



State of Illinois  
Illinois Department of Transportation

# Highway Traffic Noise Assessment Manual

2017 Edition



Illinois Department  
of Transportation

HARD COPIES UNCONTROLLED

# HIGHWAY TRAFFIC NOISE ASSESSMENT MANUAL

Illinois Department of Transportation  
Division of Highways  
Bureau of Design and Environment

Springfield, Illinois

MAY 2017



# Illinois Department of Transportation

## Departmental Policies

D&E-06

Effective Date: March 29, 2017  
Scheduled Review Date: March 29, 2022

### HIGHWAY TRAFFIC NOISE ASSESSMENT MANUAL

#### 1. POLICY

The Bureau of Design and Environment shall publish and maintain a *Highway Traffic Noise Assessment Manual* that shall be used as a basis for preparing noise analyses required for Environmental Impact Statements, Environmental Assessments, and other environmental documents and studies for projects on the State Highway System.

#### 2. PERSONS AFFECTED

Office of Highways Project implementation  
Office of Program Development

#### 3. PURPOSE

This policy is issued in order to ensure studies and reports on traffic noise prepared by or for the department are consistent with existing laws and regulations and are technically accurate and sufficient.

The manual:

- describes techniques and procedures for analyzing and reporting potential traffic noise impacts;
- describes noise barriers and other abatement measures that can be evaluated for project designs to potentially mitigate traffic noise impacts;
- describes obtaining the viewpoints of benefited receptors for noise barriers that are feasible and reasonable; and,
- includes notes, references, and examples to aid in the study of traffic noise for the presentation of study results in environmental documents.

#### 4. GUIDELINES FOR IMPLEMENTATION

The procedures and information contained in the *Highway Traffic Noise Assessment Manual* are intended to apply to all Environmental Impact Statements, Environmental

Assessments, and other environmental documents regarding traffic noise prepared by or for the department.

## 5. RESPONSIBILITIES

The **Bureau of Design & Environment** is responsible for preparing and maintaining this policy memorandum and the associated manual. Studies regarding traffic noise prepared by or for the department shall conform to this policy memorandum and the contents of the *Highway Traffic Noise Assessment Manual*.

## 6. REVISION HISTORY

Changes to this policy included in this version include:

- added the "Persons Affected" section,
- deleted "Accessibility" section,
- added "Revision History" section,
- removed the signature block, and
- made minor editorial changes and formatting updates.

Archived versions of this policy may be examined by contacting the Bureau of Design and Environment.

## CLOSING NOTICE

Supersedes: Departmental Policy D&E-6: Highway Traffic Noise Assessment Manual,  
Effective: June 29, 2011

## **FORWARD**

This guidance has been developed by the Illinois Department of Transportation (IDOT) as a companion document to the noise policy presented in Chapter 26 of the IDOT Bureau of Design and Environment (BDE) Manual. It provides technical information and procedures that should be used when performing highway traffic noise analyses in the State of Illinois.

This manual also includes a glossary of terms. An example traffic noise report outline has been included in Appendix A. Frequently asked questions and responses have been included in Appendix B. Additionally, Appendix C contains two example noise abatement evaluations.

The procedures presented herein are based on the Federal Highway Administration's (FHWA), Title 23 of the Code of Federal Regulations, Part 772 and the "Highway Traffic Noise: Analysis and Abatement Guidance" dated June 2010, January 2011, as revised. This document replaces the 2011 IDOT Highway Traffic Noise Assessment Manual.

# TABLE OF CONTENTS

## FORWARD

1.	NOISE FUNDAMENTALS .....	1-1
1.1	Noise Metrics .....	1-1
1.2	Noise Perceptions.....	1-1
1.3	Decibel Addition .....	1-1
1.4	Common Sound Levels.....	1-2
1.5	Highway Noise Generation/Sources .....	1-2
1.6	Sound Propagation .....	1-3
2.	NOISE REGULATIONS.....	2-1
2.1	Federal Regulations .....	2-1
2.2	State Policy .....	2-1
2.3	Traffic Noise Impacts and Applicability.....	2-2
2.3.1	FHWA Regulations.....	2-2
2.3.2	IDOT Noise Policy .....	2-4
3.	TRAFFIC NOISE ANALYSIS.....	3-1
3.1	Section Overview .....	3-1
3.2	Analysis Applicability .....	3-1
3.3	Objectives of the Traffic Noise Analysis Process.....	3-3
3.4	Common Noise Environments and Noise Receptors .....	3-5
3.4.1	Noise Receptor Location.....	3-7
3.4.2	Interior and Exterior Noise .....	3-9
3.4.3	Traffic Noise Analysis for Undeveloped Lands.....	3-9
3.5	Noise Monitoring .....	3-11
3.5.1	Applicability .....	3-12
3.5.2	Methodology .....	3-12
3.5.3	Noise Model Validation .....	3-15
3.5.4	Calibration of Monitoring Equipment.....	3-16
3.6	Traffic Noise Model (TNM) .....	3-17
3.6.1	Traffic Volumes .....	3-17
3.6.2	Traffic Speed.....	3-18
3.6.3	Traffic Composition .....	3-19
3.6.4	Pavement Type.....	3-19
3.7	Traffic Noise Level Predictions .....	3-19
3.7.1	Prediction of Interior Noise Levels .....	3-19

3.7.2 Scenarios Evaluated .....	3-20
3.7.3 Comparison to Criteria/Impact Determination.....	3-20
3.7.4 Documentation .....	3-20
3.7.5 Noise Contours.....	3-20
3.7.6 Weigh Stations, Rest Stops, Ride-Share Lots, or Toll Plazas .....	3-21
4. TRAFFIC NOISE ABATEMENT EVALUATION.....	4-1
4.1 Noise Abatement Measures .....	4-1
4.1.1 Construction of Noise Barriers .....	4-2
4.1.2 Traffic Management Measures .....	4-3
4.1.3 Alteration of Horizontal and Vertical Alignments.....	4-3
4.1.4 Acquisition of Property Rights for Construction of Noise Barriers.....	4-4
4.1.5 Acquisition of Undeveloped Land for Buffer Zones .....	4-4
4.1.6 Noise Insulation .....	4-4
4.2 Noise Barriers .....	4-5
4.2.1 Noise Barrier Evaluation Criteria .....	4-5
4.2.1.1 Feasibility.....	4-8
4.2.1.2 Reasonableness Criterion 1: Noise Reduction Design Goal .....	4-8
4.2.1.3 Reasonableness Criterion 2: Economic Reasonability.....	4-9
4.2.1.4 Reasonableness Criterion 3: Viewpoints of Benefited Receptors.....	4-15
4.2.2 Noise Barrier Materials.....	4-20
4.2.3 Noise Barrier Location.....	4-21
4.2.4 Noise Barrier Length.....	4-22
4.2.5 Noise Barrier Height.....	4-24
4.2.6 Parallel Noise Walls.....	4-25
4.2.7 Design Consideration.....	4-26
4.3 Right-of-Way/Pavement Treatment Considerations .....	4-27
4.3.1 Landscaping (Vegetation).....	4-27
4.3.2 Pavement Design .....	4-28
4.3.3 Sight Screens.....	4-28
5. CONSTRUCTION NOISE.....	5-1
5.1 Applicability .....	5-1
5.2 Construction Noise Evaluation .....	5-1
5.3 Construction Noise Abatement .....	5-1
5.4 Construction Noise Documentation .....	5-2
5.5 Vibration Impacts During Construction.....	5-2
5.5.1 Vibration Monitoring .....	5-3
5.5.2 Vibration Abatement.....	5-3



6. TRAFFIC NOISE REPORTING .....6-1  
6.1 Technical Memorandum/Report ..... 6-1  
6.2 NEPA Documents ..... 6-1  
6.3 Coordination with the Public ..... 6-4  
6.4 Coordination with Local Officials ..... 6-5

REFERENCES

GLOSSARY

## **TABLES**

Table 1-1	Perception of Changes in Noise .....	1-1
Table 1-2	Rules for Decibel Addition.....	1-2
Table 1-3	Common Sound Levels.....	1-2
Table 2-1	FHWA Noise Abatement Criteria-Hourly Weighted Sound Level.....	2-2
Table 2-2	IDOT Traffic Noise Levels Warranting Abatement Evaluation .....	2-4
Table 3-1	Noise Receptor Assignments.....	3-8
Table 3-2	Building Noise Reduction Factors.....	3-20
Table 4-1	Example: Including ROW Costs in Cost Effectiveness Evaluation .....	4-4
Table 4-2	Factors for Adjusting the Allowable Noise Abatement Cost per Benefited Receptor Base Value of \$30,000 Using Other Reasonableness Factors .....	4-11
Table 4-3	Example: Cost Effectiveness Analysis.....	4-12
Table 4-4	Example: Cost Averaging Table .....	4-14
Table 4-5	Number of Votes per Benefited Receptor .....	4-17
Table 6-1	Example Noise Analysis Results Summary Table .....	6-3
Table 6-2	Example Noise Abatement Summary Table .....	6-4

## **FIGURES**

Figure 1-1	Common Sounds Levels.....	1-3
Figure 1-2	Typical Truck Noise .....	1-4
Figure 1-3	Average Truck Height.....	1-4
Figure 3-1	IDOT Phase I Noise Evaluation Process .....	3-4
Figure 3-2	Common Noise Environment and Receptor Identification .....	3-5
Figure 3-3	A Common Noise Environment, Many Represented Receptors, and One Representative Receptor .....	3-6
Figure 3-4	Example of CNEs and Receptors in Urbanized Area .....	3-7
Figure 3-5	Noise Analysis Procedures for Undeveloped Lands.....	3-11
Figure 3-6	Noise Monitoring from a Secondary Location .....	3-14
Figure 3-7	Noise Model Validation Process.....	3-16
Figure 4-1	Cross-Sections of Noise Walls and Berms .....	4-2
Figure 4-2	Noise Abatement Analysis Procedures .....	4-7
Figure 4-3	Example: Front Row Receptors.....	4-17
Figure 4-4	4D Rule.....	4-22
Figure 4-5	Noise Barrier Height Changes .....	4-25

APPENDIX A - TRAFFIC NOISE REPORT SUGGESTED OUTLINE

APPENDIX B - FREQUENTLY ASKED QUESTIONS

APPENDIX C - EXAMPLE EVALUATIONS

# 1. NOISE FUNDAMENTALS

This section presents an overview of basic sound concepts and how they relate to highway traffic noise. This includes general discussions on the definition of noise, how noise is measured, how noise is perceived, how noise changes with distance, and how mobile sources affect noise.

## 1.1 Noise Metrics

It is important to first differentiate between sound and noise. Sound is vibratory disturbance capable of being detected by the ear while noise is considered unwanted sound that may interfere with normal activities. Sound is produced by the vibration of sound pressure waves in the air and its loudness is measured on a logarithmic scale using units of decibels (dB). The decibel expresses the ratio of the sound pressure level being measured to a standard reference level. Sound is composed of a wide range of frequencies; however, the human ear is not uniformly sensitive. The average human with normal hearing can only hear sounds with frequencies ranging from 20 to 20,000 Hertz. Therefore, the “A-weighted” decibel scale was devised to correspond with the ear's sensitivity. The resulting unit of measurement is the dB(A).

The intensity of noise fluctuates with time and therefore the equivalent sound level ( $L_{eq}$ ) is used.  $L_{eq}$  is defined as the steady-state, A-weighted sound level that contains the same amount of acoustic energy as the actual time-varying, A-weighted sound level over a specified period. If the period is one hour, the descriptor is the hourly equivalent sound level or  $L_{eq}(h)$ , which is widely used by State highway agencies as a descriptor of traffic noise.

## 1.2 Noise Perceptions

The loudness of noise is measured using decibels (dB), which are established on a logarithmic scale because the human ear reacts to logarithmic changes in noise levels. A change of 3 dB(A) is a barely perceivable change in noise, while an increase of 10 dB(A) is perceived as being twice as loud. Table 1-1 shows the perceived changes in noise levels relative to the decibel scale (FHWA 2011).

**TABLE 1-1  
PERCEPTION OF CHANGES IN NOISE**

<b>Change in Noise Level</b>	<b>Perception of Change</b>
+/- 3 dB(A)	Barely Perceivable Change
+/- 5 dB(A)	Readily Perceivable Change
+/- 10 dB(A)	Doubling/Halving Noise Loudness

## 1.3 Decibel Addition

Because noise loudness is measured on a logarithmic scale, sound levels cannot be added or subtracted by ordinary arithmetic methods. For example, exposure to two 60 dB(A) noise sources does not correspond to a 120 dB(A) noise level. Rather, due to the logarithmic scale, two sources of equal noise added together (i.e., a doubling of the noise source) results in an increase of 3 dB(A). That is, 60 dB(A) plus 60 dB(A) yields a total noise level

of 63 dB(A). Applying this to traffic noise, doubling traffic volumes will increase the noise level by 3 dB(A).

Table 1-2 provides general principles for adding two noise sources together. When two or more sound levels differ by 10 or more dB, the higher level dominates with no contribution from the lesser level(s).

**TABLE 1-2  
RULES FOR DECIBEL ADDITION**

Difference between sound levels (dB)	Amount to add to higher value (dB)
0 to 1	3
2 to 3	2
4 to 9	1
10 or more	0

#### 1.4 Common Sound Levels

Figure 1-1 page shows representative sound pressure levels (decibels) for a variety of common indoor and outdoor activities. To put common sound levels into perspective, normal speech at a distance of 3 feet is approximately 65 dB(A).

#### 1.5 Highway Noise Generation/Sources

Highway noise generation is dependent on three main factors: traffic volume, traffic speed, and the number of trucks within the traffic. Each of these varies at any given moment. The dominant noise sources vary by speed and by vehicle type (i.e., car vs. heavy truck). Table 1-3 summarizes the dominant noise sources for low and high speeds.

**TABLE 1-3  
PRIMARY MOBILE NOISE SOURCES**

Low Speeds	<ul style="list-style-type: none"> <li>➤ Engine</li> <li>➤ Gear Box and Transmission</li> <li>➤ Exhaust</li> </ul>
High Speeds	<ul style="list-style-type: none"> <li>➤ Tire/Road Noise</li> <li>➤ Aerodynamics of Vehicle</li> </ul>

Noise from vehicles occurs from tire interaction with the pavement and is characterized as the “whine” of traffic noise. While automobile noise is reasonably concentrated at one location on the vehicle, heavy truck noise is made up of three major sources: engine noise, exhaust noise, and tire/pavement noise. Figure 1-2 shows an example of how these three noise sources combine to produce a typical truck noise level of 82 dB(A) at an arbitrary distance from the truck.

Propulsion noise (engine, exhaust, and intake) is typically the dominant noise source when a vehicle is traveling at low speeds. Tire-pavement noise typically becomes the dominant noise source when a vehicle travels at higher speeds. Tire-pavement noise varies depending upon the characteristics of the pavement and tires used. These noise

characteristics are typically dependent upon texture (smoother tires and pavement typically result in lower noise levels), porosity (pavement porosity greater than 20% typically leads to lower noise levels, as the increased porosity absorbs noise and reduces tire contact with pavement, which also reduces noise), and stiffness (when tires and pavements have similar stiffness, noise levels are typically lower) (FHWA 2007).

The height of the noise source also contributes to the noise level. For example, the average truck height is approximately 10 feet and the exhaust outlet height (stack height) can range from 8 to 12 feet high. Figure 1-3 shows a typical stack height for a truck. The relative height of the truck noise source requires taller noise barriers for effective abatement, especially when trucks are a large percentage of the traffic volumes.

**FIGURE 1-1  
COMMON SOUND LEVELS**

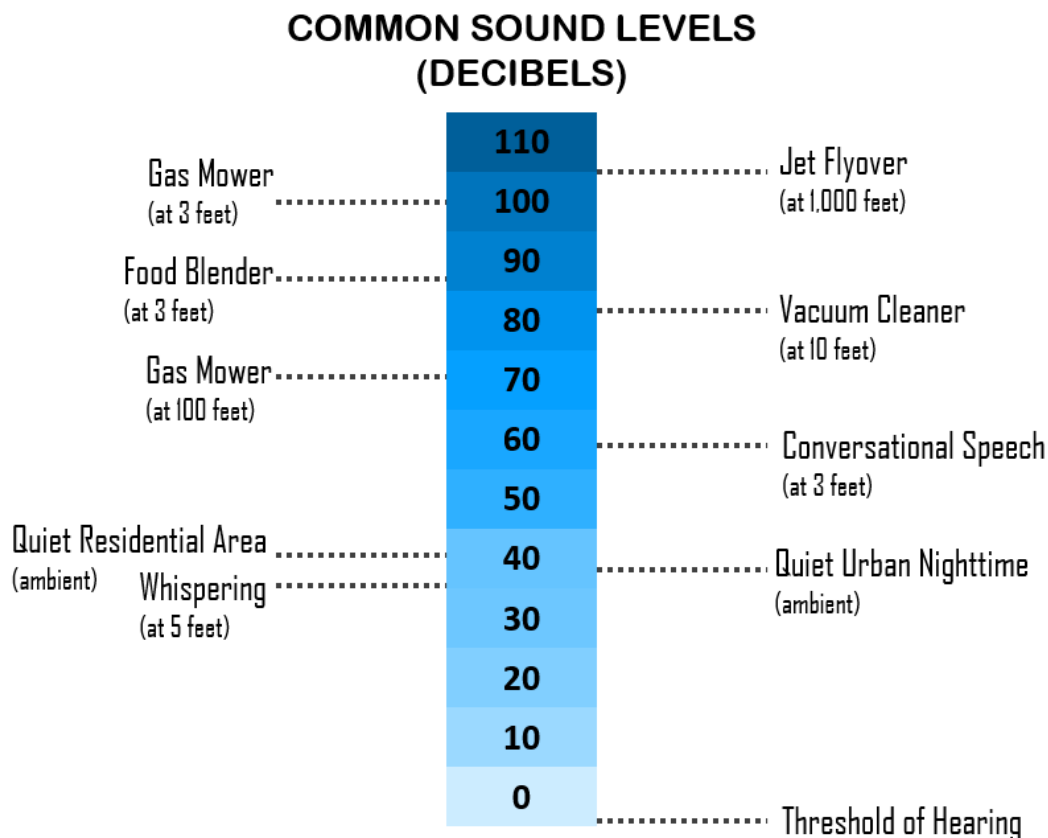

### 1.6 Sound Propagation

Highway traffic noise is generated by a line of moving vehicles closely spaced. This gives a listener the perception of a linear noise source rather than a single, identifiable point of noise. As distance increases from the highway, noise is reduced or attenuated. If all other factors are held constant and with flat topography, when distance from the noise source doubles, the noise level generally declines approximately 3 dB(A) when the sound travels over hard surfaces (FHWA 2011). Over soft surfaces, assuming flat topography, the noise level will decline approximately 4.5 dB(A) for every doubling of distance.

For example, if grass is the predominant ground cover (soft site), with a traffic noise level of 75 dB(A) at 50 feet from the roadway, the noise level at 100 feet would be 4.5 dB(A) lower,

or 70.5 dB(A), and at 200 feet the noise level would be 9 dB(A) lower, or 66 dB(A). If asphalt, brick, or concrete is the predominant ground cover (hard site), the resulting noise level at 100 feet would be 3 dB(A) lower, or 72 dB(A), and at 200 feet, will be 6 dB(A) lower, or 69 dB(A).

**FIGURE 1-2  
TYPICAL TRUCK NOISE**

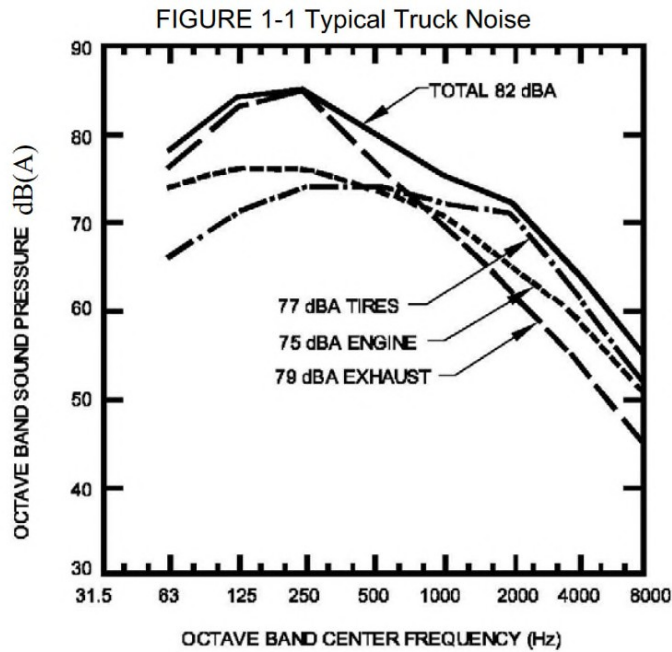

**FIGURE 1-3  
AVERAGE TRUCK HEIGHT**

FIGURE 1-2 Average Truck Height

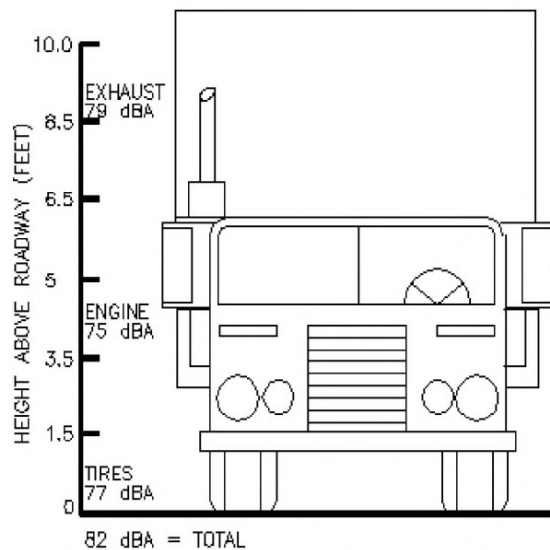

Source: Highway Traffic Noise Sources  
U.S. Dept. of Transportation

## 2. NOISE REGULATIONS

### 2.1 Federal Regulations

The following regulations and guidelines provide the legal authority and guidance for the noise analysis procedures presented in this Manual:

- National Environmental Policy Act of 1969
- Federal-aid Highway Act of 1970
- Noise Control Act of 1972
- FHWA Noise Standards - 23 CFR Part 772 “Procedures for Abatement of Highway Traffic Noise and Construction Noise”
- FHWA Policy and Guidance - “Highway Traffic Noise: Analysis and Abatement Guidance”, June 2010, December 2011, as revised.

The 1969 National Environmental Policy Act (NEPA) established the decision-making framework for Federal actions. The evaluation and mitigation of potential adverse environmental effects, including traffic noise, are to be considered during the decision-making process. However, NEPA does not establish the criteria for the evaluation of impacts. The FHWA has the responsibility to protect the public health and welfare during the planning and design of a highway project. The Federal-aid Highway Act of 1970 required FHWA to develop noise standards and abatement requirements for highway traffic noise. These standards are contained in The FHWA highway traffic noise regulation 23 CFR 772. The regulation requires the following during the planning and design of a highway project: (1) identification of highway traffic noise impacts; (2) examination of potential abatement measures; (3) the incorporation of reasonable and feasible highway traffic noise abatement measures into the highway project; (4) coordination with local officials to provide helpful information on compatible land use planning and control; and (5) identification and incorporation of necessary measures to abate construction noise. The Federal regulations were specifically written to allow flexibility in the development of State policies appropriate for the resources and other influences specific to the State. The FHWA Guidance Manual, *Highway Traffic Noise: Analysis and Abatement Guidance* (FHWA 2011) gives State transportation agencies guidance to develop their own State policies.

The Noise Control Act of 1972 establishes the authority for Federal agencies to regulate noise emissions from specific sources, such as commercial products, aircraft, railroads and motor vehicles. Noise emission standards are regulated by the U.S. Environmental Protection Agency (USEPA), not by FHWA or IDOT.

### 2.2 State Policy

The FHWA regulations purposely give flexibility to each individual State’s Department of Transportation (DOT) for determining and evaluating noise impacts. In Illinois, Chapter 26-6 of IDOT’s Bureau of Design and Environment (BDE) Manual outlines the IDOT *Noise Analyses* policy. The policy states that:

“Special efforts shall be made in the development of a project to comply with Federal and State requirements for noise control; to consult with appropriate officials to obtain the views of the affected community regarding local noise requirements, noise impacts, and abatement measures; and to mitigate highway-related noise impacts, where feasible and

reasonable. The reasonableness evaluation for noise abatement will include the solicitation of viewpoints from benefited receptors.”

This policy statement sets forth the intent of the traffic noise analyses, the identification of traffic noise impacts, and the need to offer abatement where feasible and reasonableness criteria have been met.

## 2.3 Traffic Noise Impacts and Applicability

### 2.3.1 FHWA Regulations

Based on land use, seven separate activity categories are used by FHWA to assess potential noise impacts as defined by 23 CFR 772. Five of the seven activity categories have Noise Abatement Criteria (NAC) that establish noise levels where noise abatement needs to be evaluated. FHWA considered several approaches to define impact levels, but generally based the criteria on noise levels associated with the interference of speech communication. The NAC are therefore a balance of what is desirable and what is generally achievable (FHWA 2011).

A traffic noise impact occurs on a project when predicted build noise levels approach, meet or exceed the NAC criteria listed in the following table or when the predicted noise levels are substantially higher than the existing noise level.

**TABLE 2-1  
FHWA NOISE ABATEMENT CRITERIA - HOURLY WEIGHTED SOUND LEVEL**

Activity Category	$L_{eq}(h)$	Evaluation Location	Description of Activity Category
A	57	Exterior	Lands on which serenity and quiet are of extraordinary significance and serve an important public need and where the preservation of those qualities is essential if the area is to continue to serve its intended purpose.
B <sup>1</sup>	67	Exterior	Residential.
C <sup>1</sup>	67	Exterior	Active sport areas, amphitheaters, auditoriums, campgrounds, cemeteries, day care centers, hospitals, libraries, medical facilities, parks, picnic areas, places of worship, playgrounds, public meeting rooms, public or nonprofit institutional structures, radio studios, recording studios, recreation areas, Section 4(f) sites, schools, television studios, trails and trail crossings.
D	52	Interior	Auditoriums, day care centers, hospitals, libraries, medical facilities, places of worship, public meeting rooms, public or nonprofit institutional structures, radio studios, recording studios, schools, and television studios.
E <sup>1</sup>	72	Exterior	Hotels, motels, offices, restaurants/bars, and other developed lands, properties or activities not included in A-D or F.
F	---	---	Agriculture, airports, bus yards, emergency services, industrial, logging, maintenance facilities, manufacturing, mining, rail yards, retail facilities, shipyards, utilities (water resources, water treatment, electrical), and warehousing.
G	---	---	Undeveloped lands that are not permitted.

<sup>1</sup> Includes undeveloped lands permitted for this activity category



FHWA has deferred to the State agencies to define the noise level that “approaches” the NAC and to define a “substantial” increase in traffic noise levels. It should be noted that the NAC are not used as goals for noise attenuation design criteria or design targets. Instead, the NAC are noise impact thresholds for considering abatement when they are approached, met, or exceeded. Noise abatement measures are required to be considered as part of the project if impacts are identified.

Examples of Activity Category A may include a monastery or an outdoor prayer area. Areas to be evaluated as Activity Category A shall be reviewed by FHWA on a case-by-case basis for approval by submitting a justification for the use of this designation. Activity Categories F and G do not have NAC established; however, the prediction of traffic noise levels may be required for reporting purposes as presented in Section 6. The technical noise memorandum or report should designate and analyze all land uses within the project corridor, including Activity Category F.

The NAC and noise procedure regulations apply to Type I and Type II (retrofit) projects only; however, IDOT does not maintain a Type II program.

Type I projects are defined as follows:

- The construction of a highway on new location; or,
- The physical alteration of an existing highway where there is either:
  - + *Substantial Horizontal Alteration*. A project that halves the distance between the traffic noise source and the closest receptor between the existing condition to the future build condition; or,
  - + *Substantial Vertical Alteration*. A project that removes shielding and therefore, exposing the line-of-sight between the receptor and the traffic noise source. This is done by either altering the vertical alignment of the highway or by altering the topography between the highway traffic noise source and the receptor; or,
- The addition of a through-traffic lane(s). This includes the addition of a through-traffic lane that functions as a High Occupancy Vehicle (HOV) lane, High-Occupancy Toll (HOT) lane, bus lane, or truck climbing lane; or,
- The addition of an auxiliary lane<sup>1</sup>, except for when the auxiliary lane is a turn lane (FHWA 2015); or,
- The addition or relocation of interchange lanes or ramps added to a quadrant to complete an existing partial interchange; or,
- Restriping existing pavement for the purpose of adding a through-traffic lane or an auxiliary lane; or,
- The addition of a new or substantial alteration of a weigh station, rest stop, ride-share lot or toll plaza.

If any part of a project is determined to be a Type I project under this definition, then the entire project area as defined in the NEPA document is a Type I project. In addition, a Type III project is defined as a Federal-aid highway project that does not meet the classifications of a Type I or Type II project. Type III projects do not require a noise analysis.

---

<sup>1</sup> See glossary definition of auxiliary lane

### 2.3.2 IDOT Noise Policy

The IDOT Noise Policy establishes the traffic noise analysis requirements for all Type I projects, whether they are federally funded or state-only funded, which includes cost-sharing projects with local funds. The traffic noise impact determination is based on the FHWA NAC as set forth in IDOT's policy found in Chapter 26-6.05(c) (Traffic Noise Analysis) of the BDE Manual (IDOT 2016). IDOT has established the following criteria to define the occurrence of a traffic noise impact.

- Design year (typically 20 years into the future) traffic noise levels are predicted to approach, meet, or exceed the NAC, with approach defined as 1 dB(A) less than NAC; or
- Design year (typically 20 years into the future) traffic noise levels are predicted to substantially increase (15 dB(A) or greater) over existing noise levels.

Based on the approach definition determined by IDOT, Table 2-2 provides the noise levels at which a traffic noise impact would occur and would require consideration of traffic noise abatement for the design year.

**TABLE 2-2  
IDOT TRAFFIC NOISE LEVELS WARRANTING ABATEMENT EVALUATION**

<b>Activity Category</b>	<b><math>L_{eq}(h)</math>, dB(A)</b>	<b>Evaluation Location</b>
A	56	Exterior
B	66	Exterior
C	66	Exterior
D	51	Interior
E	71	Exterior
F	---	---
G	---	---

## 3. TRAFFIC NOISE ANALYSIS

### 3.1 Section Overview

This section describes the appropriate traffic noise analysis approach and the procedures for conducting a traffic noise analysis. The following topics are presented:

- 3.2 Analysis Applicability
- 3.3 Objectives of the Traffic Noise Analysis Process
- 3.4 Receptor Selection
- 3.5 Noise Monitoring
- 3.6 Traffic Noise Model (TNM)
- 3.7 Traffic Noise Level Predictions

### 3.2 Analysis Applicability

The noise analysis and abatement procedures shall apply to all Type I projects, whether federally funded or state-only funded, which includes state and local-funded projects. Type I projects are defined in 23 CFR 772 and include the following discussed herein:

#### **Construction of a Highway on New Location**

Identification of the construction of a highway on new location is generally self-explanatory. In most cases, there is no roadway in the existing condition and the proposed project is construction of a new roadway. This also includes the evaluation of new interchanges and ramps on existing highways.

#### **Physical Alteration of an Existing Highway**

Identification of the physical alteration of an existing highway that substantially alters either the horizontal or vertical alignment requires evaluation on a case-by-case basis. FHWA defines a substantial alteration as follows:

*Substantial Horizontal Alteration.* A project that halves the distance between the traffic noise source and the closest receptor between the existing condition to the future build condition; or,

*Substantial Vertical Alteration.* A project that removes shielding, therefore, exposing the line-of-sight between the receptor and the traffic noise source. This is done by either altering the vertical alignment of the highway or by altering the topography between the highway traffic noise source and the receptor. The removal of an existing noise barrier constitutes a Type I project, as it is a substantial vertical alteration.

#### **Addition of Through-traffic Lanes**

Based on FHWA guidance, identification of the physical alteration of an existing highway that increases the number of through traffic lanes requires consideration of the through traveled way, which is the portion of the highway constructed for the movement of vehicles, not including shoulders and auxiliary lanes. Identification of the physical alteration of an

existing highway that increases the number of through traffic lanes requires considering the through traveled way, that portion of the highway constructed for the movement of vehicles, exclusive of the shoulders and turn lanes. The addition of a full lane to the mainline of a highway is a Type I project.

The addition of high-occupancy vehicle (HOV) lanes, high-occupancy toll (HOT) lanes, bus lanes and truck climbing lanes are considered Type I projects. These additions are Type I projects regardless of length.

### **Addition of an Auxiliary Lane**

The American Association of State Highway Transportation Officials (AASHTO) defines an auxiliary lane as the portion of the roadway adjoining the traveled way for speed change, turning, weaving, truck climbing, maneuvering of entering and leaving traffic, and other purposes supplementary to through-traffic movement (AASHTO, 2001).

The Department will take a broad approach to defining auxiliary lanes with respect to defining a Type I project for noise analysis. FHWA states that auxiliary lanes 2,500' or longer should be considered a Type 1 project. For auxiliary lanes shorter than 2,500' in length, consideration for auxiliary lanes should be limited to those that could be used as a through lane (including bus or truck lanes) rather than lanes used for parking, speed change, turning or storage for weaving. For interstates, auxiliary lanes considered to be Type 1 projects are those that are:

1. more than 2,500' long, and;
2. are between two closely spaced interchanges or carried through one or more interchanges.

The final determination regarding Type 1 project classification will be left to the IDOT District and the Bureau of Design and Environment, on a case-by-case basis.

### **Addition or Relocation of Interchange Lanes or Ramps to Complete a Partial Interchange**

The addition or relocation of interchange lanes or ramps to complete an existing partial interchange is considered a Type I project, as the proposed project has the potential to increase the interchange capacity. The relocation of interchange lanes or ramps at an existing full interchange would need to be evaluated to determine if the shift in alignment would be considered a substantial shift in alignment.

### **Restriping Existing Pavement to Add a Through-traffic Lane or Auxiliary Lane**

Restriping existing pavement to add an additional travel lane to add capacity would be considered a Type I project. The auxiliary lane added by restriping also would be considered a Type I project.

### **Addition of a New or Substantial Alteration of a Weigh Station, Rest Stop, Ride-share Lot, or Toll Plaza**

Construction of a new weigh station, rest stop, ride-share lot or toll plaza would be considered a Type I project due to the addition of a new noise source. Substantial alterations to existing facilities would need to be considered using the same substantial alteration guidance provided for "Physical Alteration of an Existing Highway."

### **Consideration of Entire Project as Type I**

If any part of a project meets the definition of a Type I project, then the entire project area as defined in the NEPA document needs to be evaluated for traffic noise. For example, if an arterial road is being improved by the addition of a new interstate interchange, traffic noise would need to be evaluated for the entire project area, including proposed improvements to all local roads within the project limits.

If the project is not a Type I project (does not meet the requirements for a traffic noise analysis), the following Type III documentation should be used in the environmental document or engineering document:

“The referenced project meets the criteria for a Type III project established in 23 CFR Part 772. Therefore, the proposed project requires no traffic noise analysis or abatement evaluation. Type III projects do not involve added capacity, construction of new through lanes, changes in the horizontal or vertical alignment of the roadway, or exposure of noise sensitive land uses to a new or existing highway noise source. A noise analysis would be required if changes to the proposed project results in reclassification to a Type I project.”

### **3.3 Objectives of the Traffic Noise Analysis Process**

The major objectives of a traffic noise analysis are to identify areas for each reasonable alternative carried forward in the “Alternatives Section” of the NEPA Document where possible traffic noise impacts may occur. The following are aspects of the traffic noise analysis:

- Determine existing traffic noise levels
- Predict future traffic noise levels (No-Action and Build)
- Identify the possible traffic noise impacts
- Consider and evaluate abatement measures to mitigate highway traffic noise impacts
- Evaluate potential construction traffic noise impacts, if necessary
- Propose implementation of feasible and reasonable abatement measures
- Document the traffic noise evaluation process
- Communicate the results to the public and local officials

The noise evaluation process is detailed in Figure 3-1.

**FIGURE 3-1  
IDOT PHASE I NOISE EVALUATION PROCESS**

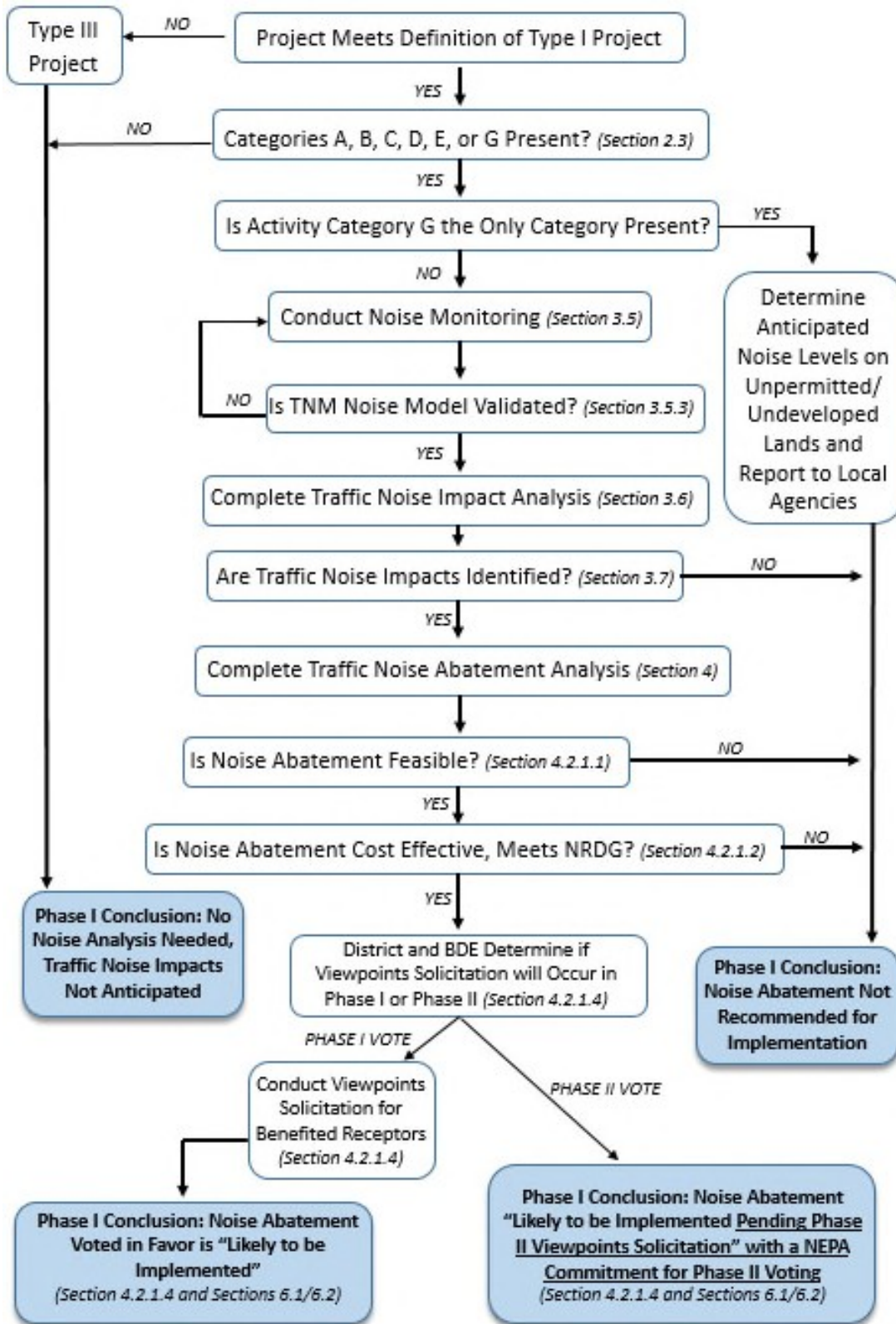

### 3.4 Common Noise Environments and Noise Receptors

A receptor is a discrete or representative location for any of the activity categories listed in Table 2-1. Primary consideration should be given to exterior areas where frequent human use occurs for Activity Categories A, B, C, and E. Consideration should be given to Activity Category D land uses only if no exterior use areas are identified.

A common noise environment (CNE) is a group of receptors in the same Activity Category that are exposed to similar noise sources and levels; traffic volumes, traffic mix, and speed; and topographic features. Figure 3-2 shows the process to identify CNEs and receptors.

**FIGURE 3-2  
COMMON NOISE ENVIRONMENT AND RECEPTOR IDENTIFICATION**

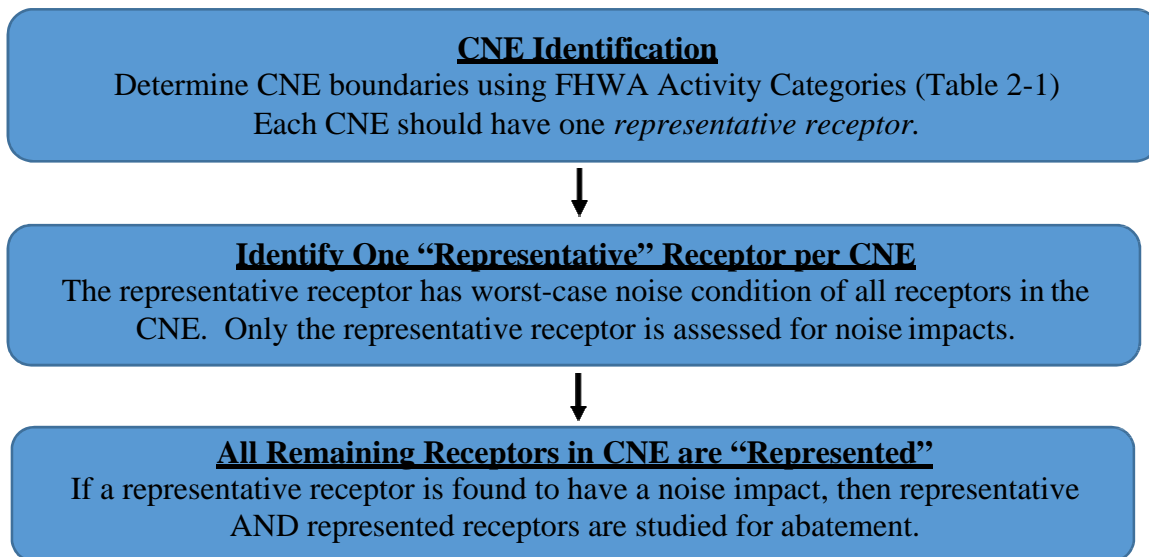

Prior to selection of receptors, land use adjacent to the proposed improvements should be assessed into FHWA Activity Categories (Table 2-1). For initial screening, land use within 500 feet of proposed improvements shall be reviewed. FHWA’s performance evaluation of TNM (FHWA 2010) found that highway traffic noise typically does not cause impacts at distances greater than 500 feet from heavily traveled freeways or more than 100 to 200 feet from lightly traveled roads. If there are sensitive receptors further than 500 feet from the roadway, these also should be considered and may be included on a case-by-case basis in the traffic noise analysis, dependent upon the sensitivity of the receptor (e.g., nursing home).

#### **How is the Representative Receptor Determined?**

If the worst-case noise condition in the CNE is not clear from aerial or field review because road geometry or topography is complex, multiple receptors may be modeled in TNM to determine the representative receptor.

When defining impacts, the traffic noise analysis report will include results for the one determined worst-case representative receptor for each CNE.

Areas to be evaluated are grouped into CNEs, which have receptors with the following characteristics:

- Same Activity Category in Table 2-1<sup>2</sup>
- Similar exposure to noise sources and levels
- Similar topography
- Similar traffic characteristics (speed, volume, truck composition)

One representative receptor is used to represent the equivalent or worst-case noise condition for all represented receptors in the CNE. Figure 3-3 shows the representative receptor as the closest receptor to the roadway, and that receptor likely has the highest noise level within the CNE. If there is no impact at the representative receptor, it is unlikely that there will be an impact at any of the remaining represented receptors, as the representative receptor is the worst-case noise condition.

**FIGURE 3-3  
A COMMON NOISE ENVIRONMENT,  
MANY REPRESENTED RECEPTORS, AND ONE REPRESENTATIVE RECEPTOR**

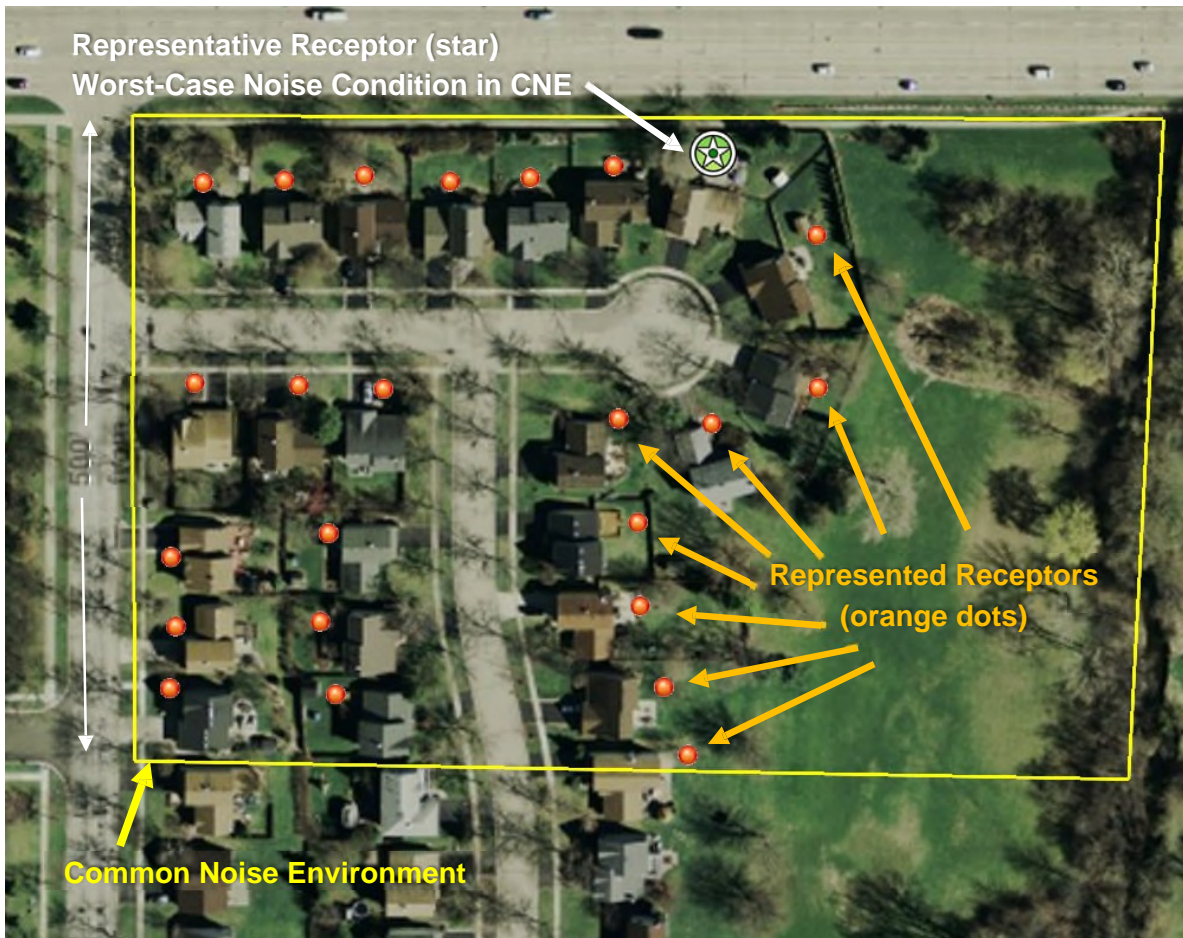

<sup>2</sup> CNEs for multi-use buildings may require assigning more than one Activity Category to the building, on a case-by-case basis; impacts are only reported for the representative receptor.



Urban areas are usually more densely developed than suburban or rural areas; densely developed urban areas typically have more and smaller CNEs as compared to less densely developed areas. This is because CNEs are separated by Activity Category. See Figure 3-4.

**FIGURE 3-4  
EXAMPLE OF CNEs AND RECEPTORS IN URBANIZED AREA**

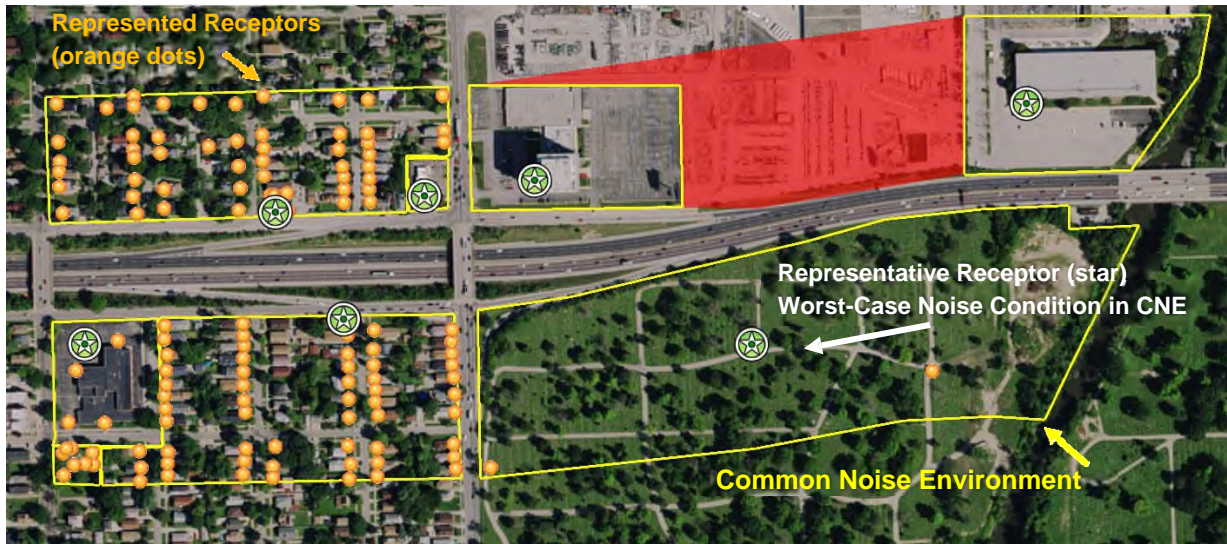

**3.4.1 Noise Receptor Location**

The receptor location should be placed in an area where frequent outdoor human activity occurs. Outdoor use areas should be confirmed via aerial photography or field review. Examples include but are not limited to those listed in Table 3-1.

**TABLE 3-1  
NOISE RECEPTOR ASSIGNMENTS**

Receptor Type	FHWA Activity Category	Receptor Unit(s)
Single-family Residence	B	Each residential unit with exterior use area (i.e., patio, yard, deck, etc.)
Multi-family Residence	B	Each residential unit with access to the exterior common area (i.e., pool, benches, or building entrance) or with exterior use areas (i.e., patio or balcony)
Nursing Home	C	Each residential unit with access to an exterior common area (i.e., benches or main entrance) or with exterior use areas (i.e., patio or balcony)
School	C	Each classroom with access to an exterior use area (i.e., benches, playground, main entrance)
Hospital or In-patient Medical Facility	C	Each hospital room with a bed(s) with access to an exterior use area (i.e., benches or main entrance)
Cemetery	C	Each exterior area of anticipated gathering (i.e., benches, information board)
Auditoriums	C	Each exterior area of anticipated gathering (i.e., bench or main entrance)
Day Care Center	C	Each exterior area of anticipated gathering (i.e., playground or main entrance)
Campground	C	Each campsite within the noise study area.
Sports Fields	C	Each exterior area of anticipated gathering (i.e., dugout, bleachers, field)
Places of Worship	C	Each exterior area of anticipated gathering (i.e., benches, patio, gazebo, or main entrance)
Golf Courses	C	One receptor per hole in the worst-case noise location (tee box, fairway, green), in addition to other exterior use areas (i.e., benches, putting green)
Parks / Recreational Area	C	Each exterior use area (i.e., gazebo, picnic tables, play equipment)
Trails and Trail Heads	C	Each exterior area of anticipated gathering (i.e., bench, information board)
Libraries*	C	Each exterior area of anticipated gathering (i.e., bench, patio, gazebo)
Office*	E	Each business with an exterior use area (i.e., bench or picnic tables)
Hotel/Motel*	E	Each hotel/motel room with access to an exterior use area
Restaurants/Bars*	E	Each exterior area of anticipated gathering (i.e., group of tables)
Medical Office or Out-patient Medical Office*	E	Each exterior area of anticipated gathering (i.e., bench or tables)
Undeveloped Lands	G	Uses with an NAC and a building permit that have access to a planned exterior use area

Note: This listing is comprehensive, but not exhaustive

\* Main entrance does not qualify as exterior area of frequent human use for the noted land use type.

There are times when traffic noise from elevated roadways may be louder on second or third floors that are within the direct line of sight of the roadway. For these situations, the receptors within the direct line of sight of the roadway, i.e., second floor apartment units, shall be evaluated under the feasibility criteria. This approach shall be used for multi-family

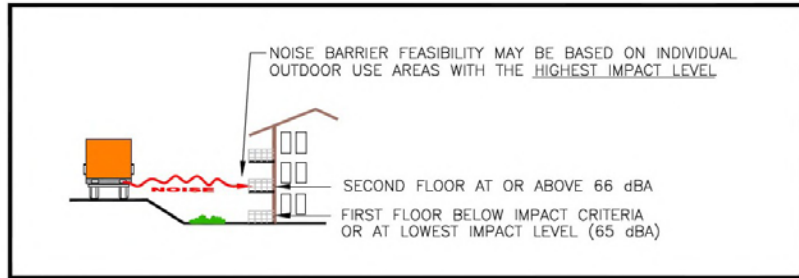
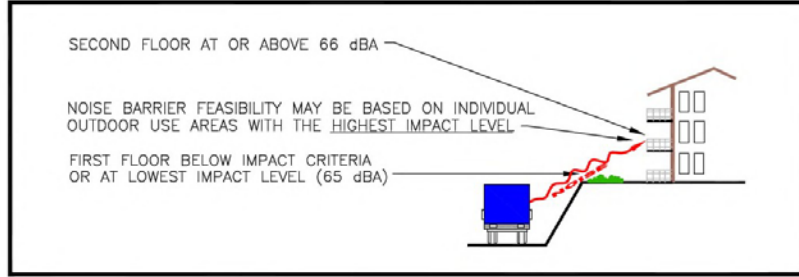

residences when ground level exterior areas do not exist, but shall not be used to address second floors of single-family residences. When identifying impacts, impacted receptors may include both ground level and higher levels within a multi-family dwelling.

**3.4.2 Interior and Exterior Noise**

The evaluation of traffic noise impacts should primarily focus on outdoor activity areas affected by traffic noise. Activity Category B land uses should always be evaluated for exterior noise. Activity Category D includes interior NAC for certain land uses; Activity Category D is appropriate to use for traffic noise impacts determinations only where there are no exterior activities affected by traffic noise, or where the exterior activities are far from or physically shielded from the roadway

**Interior Noise Impacts**

Activity Category D is appropriate to use for traffic noise impact determinations only where there are no exterior activities affected by traffic noise, or where the exterior activities are far from or physically shielded from the roadway that prevents an exterior noise impact.

in a manner that prevents an exterior noise impact (See Section 3.7.1 for interior noise level predictions). The interior analysis only should be conducted for Activity Category D land uses. Activity Category D does **not** apply to residential land uses and therefore an interior noise impact analysis would not be conducted for homes.

**3.4.3 Traffic Noise Analysis for Undeveloped Lands**

Receptors shall include presently undeveloped lands for which development of a noise sensitive land use is permitted, as evidenced by a valid building permit issued by the local agency with jurisdiction prior to the date of public knowledge. The noise analysis for the permitted development shall be for the permitted activity description. The date of public knowledge shall be the date of environmental approval of the Categorical Exclusion (CE), the Finding of No Significant Impact (for Environmental Assessment projects) or Record of Decision (for Environmental Impact Statement projects) as defined in 23 CFR Part 771. The planning and development department(s) with jurisdiction (or similar local agency

department) shall be contacted to determine if open building permits exist in the project area. See Figure 3-5 for a flowchart of undeveloped lands analysis procedures.

Receptor locations for undeveloped lands with a building permit can be approximated by reviewing available plat maps or development plans that may define individual lots or building locations. If plat maps and/or subdivision plans are not available, the location of receptors relative to the roadway may be considered as “typical” when deciding placement of receptor locations. **Noise abatement shall be evaluated for traffic noise impacts identified on undeveloped permitted lands.**

Undeveloped lands for which no permit has been obtained shall be evaluated for traffic noise for the build design year. The purpose of the evaluation is to determine the traffic noise levels if the land were to be developed so that local officials can take the traffic noise into consideration during planning of the development. The noise levels shall be determined based on both the 66 dB(A) and 71 dB(A) noise levels (Table 2-2) to identify the location where traffic noise levels approach the NAC for Activity Categories B, C, and E. Noise abatement does not need to be evaluated if traffic noise levels approach the NAC within the undeveloped and unpermitted land property boundaries. The predicted noise information will be shared with the local officials as presented in Section 6.4.

Agricultural land is identified as one of the descriptors under Activity Category F. Consequently, agricultural lands generally do not require a traffic noise impact analysis as there is no NAC applicable to any land use in this category; however, agricultural land is the most likely land use type that could be developed in the future. For purposes of sharing information with local officials (Section 6.4), lands that are currently or have been historically farmed should be reviewed to determine the current zoning if they are within a planning district or municipal boundary. If the current zoning or the local comprehensive land use plans indicate a plan to eventually develop the agricultural land, the land is recommended to be evaluated as Activity Category G (undeveloped land). The predicted noise information will be shared with the local officials as presented in Section 6.4.

**FIGURE 3-5  
NOISE ANALYSIS PROCEDURES FOR UNDEVELOPED LANDS**

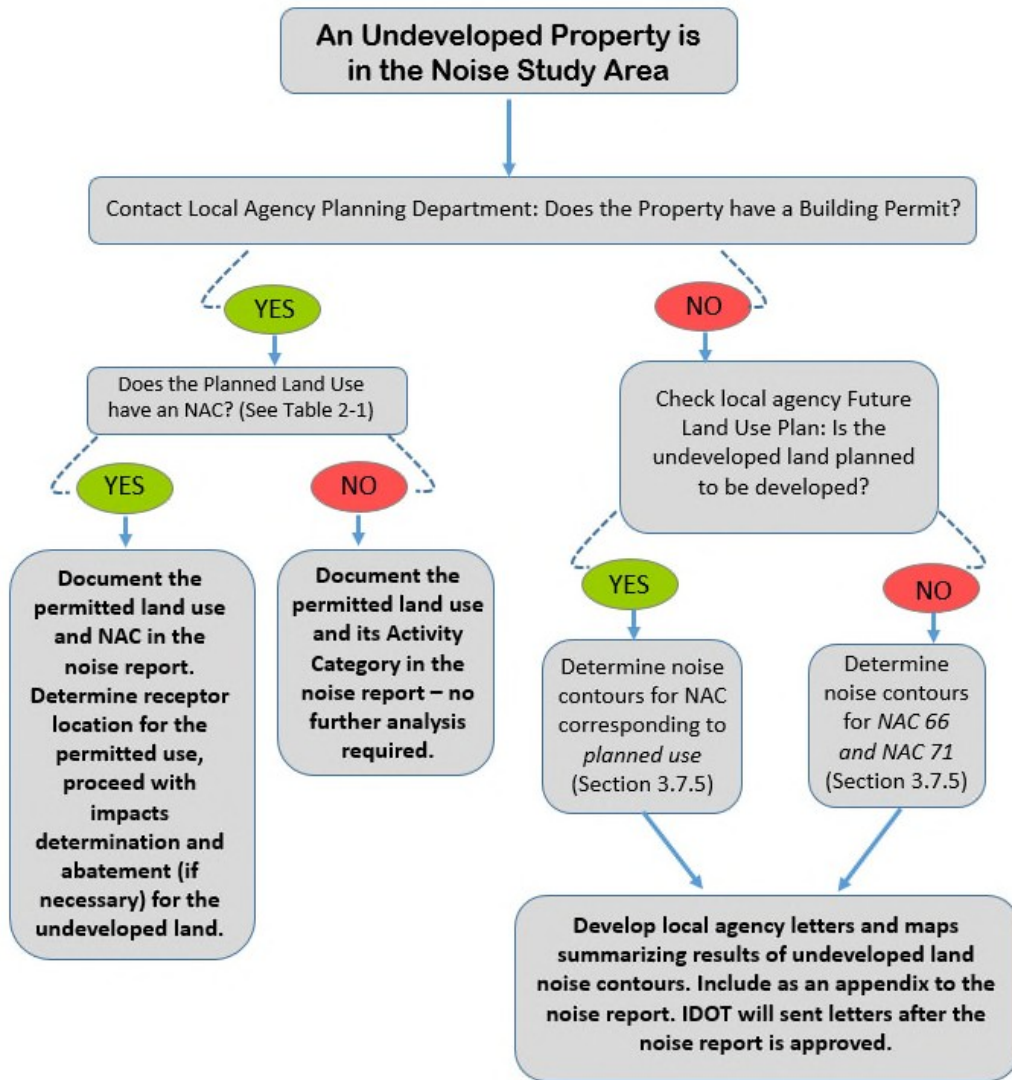

**3.5 Noise Monitoring**

Noise monitoring is physically measuring noise levels at a particular representative receptor. The following sections briefly describe noise monitoring procedures; however, when conducting noise monitoring for a highway project, the following document should be referenced for comprehensive guidance:

“Measurement of Highway Related Noise,” by the U.S. Department of Transportation, Federal Highway Administration, Office of Environment and Planning, Washington, D.C., May 1996. [FHWA-PD-96-046, DOT-VNTSC-FHWA-96-5.]

### 3.5.1 Applicability

Noise monitoring is generally required for every proposed Type I highway project. Appropriate use of noise monitoring may include the following:

- **Projects that include construction of a new roadway** - When there is no roadway in the existing condition and there is no dominant traffic noise source, a computer model cannot be used for the existing condition and existing noise levels must be determined by noise monitoring.
- **Projects with high public interest** - Conducting noise monitoring when there is a high degree of public interest can help generate greater public involvement and confidence.
- **Other major background noise is present** - Computer noise modeling is only applicable to noise originating from the roadway traffic and should not be used if there is background noise that may be impacting the traffic noise levels; however, if the roadway traffic is the dominant source, then the existing traffic noise levels may be calculated using the traffic noise model.
- **Model Validation** - Federal regulations require validation of the traffic noise model to increase confidence in the accuracy of the model runs used to predict the existing noise levels for the project.

### 3.5.2 Methodology

The purpose of noise monitoring is to validate the project-specific use of TNM and ensure that TNM properly accounts for project-level variables. Noise monitoring is conducted at selected representative receptors to measure existing noise levels. There are two types of sound level meters: Type 1 and 2 as determined by the American National Standards Institute (ANSI S1.4-1983). Use a noise meter with sufficient accuracy to yield valid data for the particular project (ANSI S1.4-1983, Type II or better). The monitoring procedures used should allow for consistent and supportable measurements.

The sound level meter is placed on a tripod approximately five (5) feet high. The noise meter shall be placed a sufficient distance from reflective surfaces to avoid capturing reflected sound. Generally, the microphone should be at least 10 feet from reflecting surfaces on all sides.

The duration of the monitoring period is based on the characteristics of the noise source. FHWA generally suggests sampling periods that range from 8 to 15 minutes, depending on the range of noise levels anticipated and the temporal nature of the noise sources. Measurements along low-volume highways may require longer measurements of 30 to 60 minutes. The objective of establishing a sampling period is to obtain a steady-state equivalent noise level. The need for repetitive measurements shall be considered on a case-by-case basis using professional judgment.

Actual noise level measurements characterize existing noise conditions only at the time of measurement. Traffic volumes and other conditions present during the noise measurements also should be considered when evaluating field measurements as typical for the area. The following methodology is therefore offered for collecting and using noise level measurements.

### Monitoring of Representative Locations

Measurements should be taken at representative receptors located within the project area, such as residences, schools, churches, libraries, etc.; however, not all receptors chosen for computer modeling need to be monitored. Twenty-five (25) to fifty (50) percent of representative receptors for the project typically must be monitored to allow enough data for model validation. If a project area has very dense development resulting in many CNEs within the same geographic area or other factors that would result in redundant monitoring data for model validation, IDOT and FHWA approval to monitor less than 25 percent of representative receptors must be obtained prior to noise monitoring. It is recommended that IDOT and FHWA discussion and approval to monitor less than 25 percent of receptors occur at FHWA coordination meetings with the IDOT District; a short memo or a study area aerial map illustrating proposed monitoring locations and the reasons why additional monitoring locations would be redundant and not required to fully validate the model should be provided to FHWA and IDOT to consider the request.

Noise measurements are normally taken at exterior areas of frequent human use such as a patio or the yard of a home. Additional monitoring locations may be required for new highway projects where the noise monitoring will be used to establish the existing noise level data. Monitoring should be conducted at locations that correspond to the receptors that are modeled to define impacts. Noise monitoring should not be conducted in locations adjacent to the roadway that are not representative of any receptors. Again, the purpose of the monitoring is to validate (Section 3.5.3) the project-specific use of the modeling program and to ensure that the model properly accounts for the project-level variables.

IDOT recommends that the field analyst have a copy of the project's Right of Entry Letter during noise monitoring. Possession of this letter provides evidence of your reason for working in the area. The letter will list the IDOT project manager who should be contacted should the public have any questions about the project. The analyst must have the letter on their person if they must access private property for noise monitoring.

The analyst may monitor noise from a secondary location that has similar noise levels to the representative receptor being monitored. This procedure will keep noise monitoring activities off private property, with similar noise level results. Secondary monitoring locations should be located the same distance away from the noise source as the representative receptor, and as close as possible to the representative receptor.

Figure 3-6 shows an example of monitoring noise from a secondary location. The representative receptor is in a fenced-in back yard that is difficult to access, or access may not be allowed by the property owner. One secondary location is shown as "A" in Figure 3-6. This location should provide similar results to the representative receptor if the traffic on the minor intersecting street is very low. The other secondary location shown in the figure is "B." This location could be an ideal secondary monitoring location for the representative receptor if the open space shown in the aerial photography is open for public use.

**FIGURE 3-6  
NOISE MONITORING FROM A SECONDARY LOCATION**

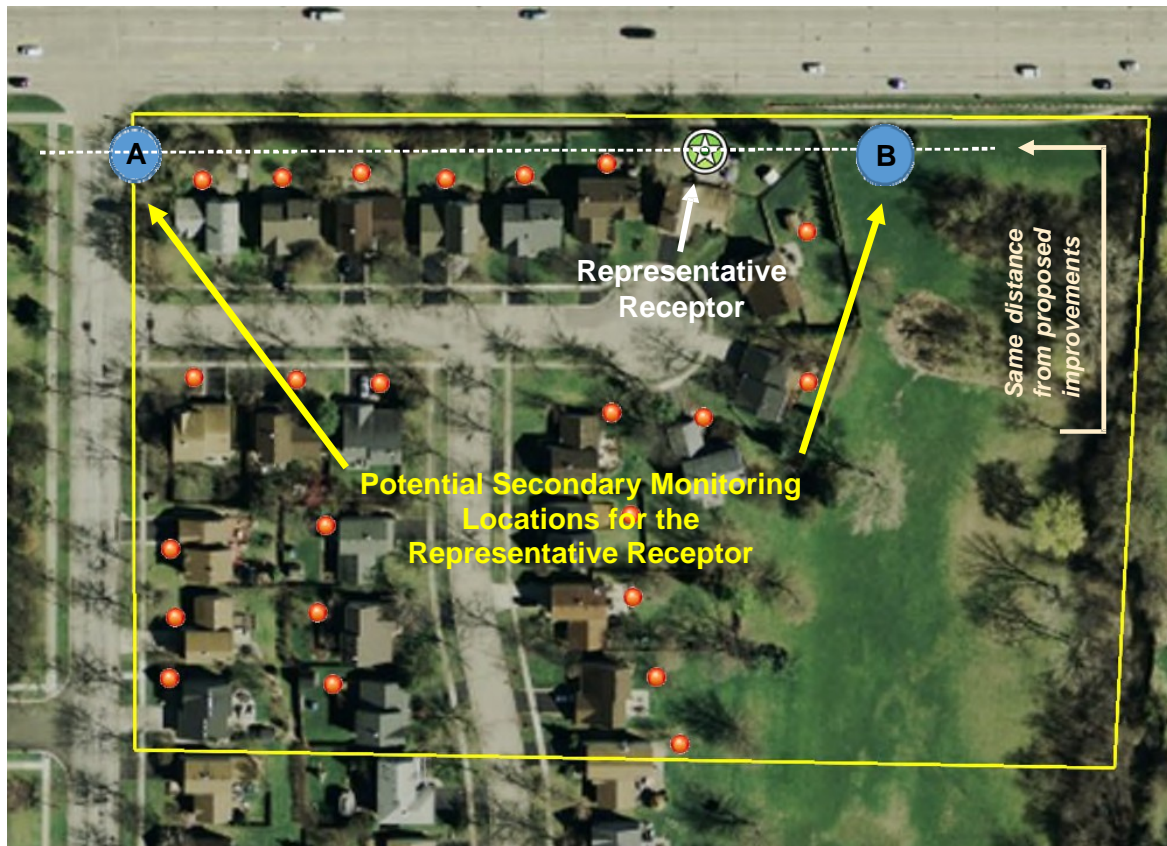

### Traffic Volumes and Speed

Traffic volumes should be documented during field monitoring by manually counting traffic on adjacent streets. The counts will include the number of automobiles, medium trucks, and heavy trucks. Average traffic speed should be measured using either a Doppler radar gun or stopwatch measurements.

### Time and Day for Measurements

Measurements should generally be conducted during the worst traffic-noise conditions. The time of day this occurs depends on the roadway being evaluated, but is typically represented by peak traffic conditions traveling at or near posted speed limits. Recommended noise monitoring periods are Tuesday through Thursday, 8 a.m. to 12 p.m. and 1 to 6 p.m.; however, site-specific conditions may warrant monitoring at a time outside these ranges, such as at night. Noise monitoring is not recommended for Mondays, Fridays, weekends or holidays unless the objective of the noise monitoring is to evaluate these time periods.

### Weather Conditions

Since weather conditions will affect noise measurement readings, a wind screen should be used at all times. If the wind speed exceeds 12 miles per hour (mph), noise measurements



should not be taken. Temperature and humidity limitations are established by the sound level meter manufacturer, but are typically limited to temperature ranging between 14 degrees F to 122 degrees F and relative humidity ranging from 5% to 90%. Other site conditions necessary during the monitoring include dry pavement and no snow cover. The weather condition information shall be documented with the noise data.

### 3.5.3 Noise Model Validation

Noise monitoring is a tool that only provides information for existing noise conditions. Computer noise modeling using the latest FHWA-approved Traffic Noise Model (TNM) is used to predict traffic noise levels for both existing and future conditions (see Section 3.6). Noise monitoring results need to be compared to the computer-predicted existing traffic noise levels in TNM to validate the accuracy of the noise model. This process is called model validation. Once the existing noise model is validated, it can be used to generate existing noise levels. Traffic and speed conditions in the model can then be revised to represent future no build conditions. The model's traffic, speed, and design can further be revised to represent future build conditions.

For a noise model to be considered validated, noise monitoring results must be within +/-3 dB(A) of the TNM generated results. If results are outside of this range, the traffic volumes, composition and speed input into TNM should be compared to the traffic volumes, composition, and speed measured during the monitoring events to evaluate potential discrepancies between the monitoring results and TNM results. Traffic data (volumes, composition and speed) collected during the noise monitoring may need to be input into the existing model and run to make the comparison. In addition, the noise monitoring data should be reviewed for potential non-traffic noise sources that may have affected the measured noise levels.

If the monitored results are still not within +/-3 dB(A) of the computer-generated results, the noise model input should be reviewed and revised as necessary, the noise monitoring should be redone, or both. If after this approach, the model is still not validated, the analyst shall document the reason for the discrepancy in the traffic noise report. For example, there may be a discrepancy if the noise monitoring data included other noise sources in the area that influenced the readings and could not be accounted for in TNM.

The noise monitoring results should not be used to generate adjustment factors or receiver adjustments to be used in TNM to account for the discrepancy. Other factors to consider include ground cover, building rows, ground zones, or terrain lines. All these have the potential to affect noise that may need to be accounted for in TNM.

At least twenty-five (25) percent of represented receptors should have field-validated modeling results prior to proceeding with model development for impact analysis.<sup>3</sup> If at least 25% of represented receptors cannot be validated, further modeling revisions or remonitoring select receptors may be required. When at least 25% of representative receptors are validated, the existing conditions base model is considered validated. This existing conditions base model can then be used to develop existing conditions, future no build conditions, and future build conditions noise models for impact analysis.

The model validation process is illustrated in Figure 3-7.

---

<sup>3</sup> If FHWA and IDOT allow less than 25% of receptors to be monitored for a project in certain circumstances (see Section 3.5.2), the analyst shall attempt to validate as many receptors as possible to ensure model accuracy.

**FIGURE 3-7  
NOISE MODEL VALIDATION PROCESS**

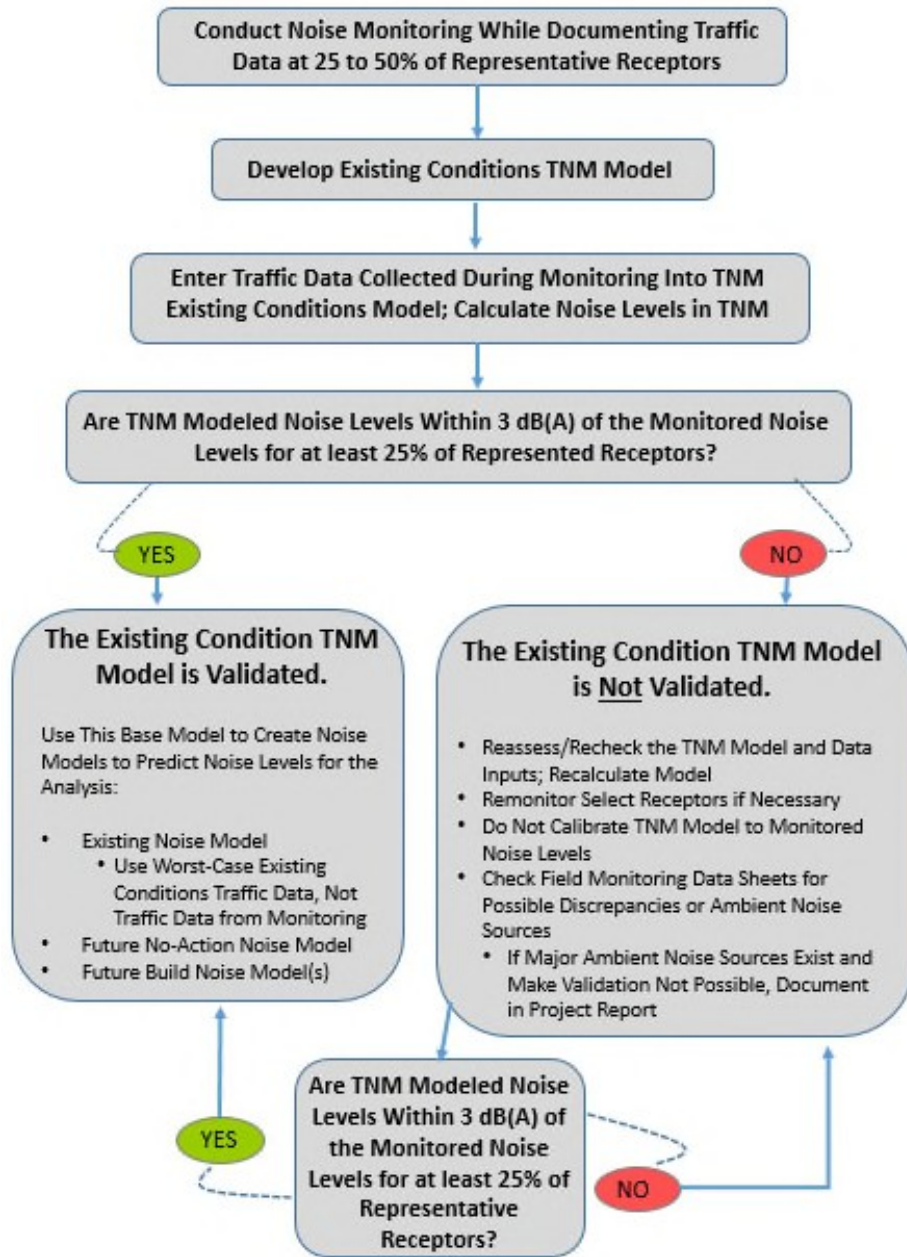

**3.5.4 Calibration of Monitoring Equipment**

Monitoring equipment calibration generally is conducted at two levels: laboratory calibration and field calibration. As per FHWA’s *Measurement of Highway Related Noise* (FHWA 1996), all acoustical instrumentation should be calibrated annually by the manufacturer or other certified laboratory to verify accuracy. An acoustical calibrator is typically a handheld instrument that is used to calibrate the meter in the field. Calibration using the acoustical calibrator should be conducted at the beginning and end of each measurement session and before and after any changes made to the meter settings or components.

### 3.6 Traffic Noise Model (TNM)

Predict the traffic noise levels for each reasonable alternative carried forward under detailed study (including the “no-action” alternative) using the most current version of the FHWA-approved Traffic Noise Model (TNM), which is described in “FHWA Traffic Noise Model” Report No. FHWA-PD-96-010 (FHWA 1998), or any other model determined by the FHWA to be consistent with the methodology of the FHWA TNM.

The main TNM inputs to estimate traffic noise include:

- Traffic Volumes
- Traffic Speed
- Traffic Composition
- Receptor Location and Elevation
- Roadway Alignment (Horizontal and Vertical)
- Terrain Lines
- Ground Zones (i.e., Detention Ponds, High Grass Areas)
- Building Rows
- Tree Zones
- Traffic Control Devices (i.e., Stop Signs, Traffic Signals)
- Pavement Type

Information sources for traffic volumes, traffic speed, traffic composition, and pavement type are briefly described in the following subsections.

#### 3.6.1 Traffic Volumes

The objective of the traffic noise analysis is to predict the worst hour traffic noise conditions. The traffic data that should be used are the highest volumes of traffic that can travel at the highest possible speed for the particular roadway, which is generally approximated by Level of Service (LOS) “C” conditions. This is typically represented by the design hourly volume (DHV). The traffic volumes can be obtained from traffic counts or intersection design sheets. If traffic volumes have not been manually conducted for the project, general traffic counts are available on the IDOT website ([www.gettingaroundillinois.com](http://www.gettingaroundillinois.com)). Design hourly traffic volumes can be estimated as approximately 6 to 10 percent of the Average Daily Traffic (ADT), with 6 percent being typical in rural areas and 10 percent typical in the more urban areas including the six county Chicago metropolitan area. In all cases, the best available traffic data shall be utilized for the TNM noise level predictions.

Generally, FHWA’s recommended process for traffic volume data for noise modeling (Bajdek, et al 2016) should be followed:

- If hourly traffic data (for a typical 15-hour or 24-hour period) are developed for the project, conduct a loudest-hour analysis, as described below:
  - Determine hourly breakdown of vehicle volumes and corresponding speeds for each mainline section of the highway.
  - Develop a generic TNM model for the highway and compute hourly equivalent sound levels ( $L_{eq}$ ) at a few representative distances from the highway, using the traffic conditions from the previous step.

- If the traffic data exhibit strong directional characteristics, consider including representative receivers on both sides of the highway in the generic TNM model.
- Identify the traffic conditions (and the hour(s)) that produce the highest noise levels at the representative receivers, then:
  - Either use the traffic conditions that produce the loudest hourly noise levels;
 or
  - Explicitly model the highway geometry in the FHWA TNM for the "top" two hours, for a small number of actual receivers. Use the traffic conditions that produce the highest noise levels for the study-wide prediction of traffic noise levels.
- If hourly traffic data are not developed for the project:
  - Consider a long-term (minimum 15 to 24 hours) noise monitoring program to measure traffic noise levels at representative noise-sensitive sites adjacent to the highway corridor. Identify the hour that produced the highest measured noise levels. Determine traffic conditions for that hour for use in the FHWA TNM.
  - If future build alternative speeds during the hour are projected to be lower than the posted speed, use the posted speed along with the projected volumes in the build alternative for TNM modeling.
  - Use the DHV and the design speed for the highway; where the design speed is approximately the posted speed plus 10 mph. Note that depending upon the actual design parameters for a highway, this approach has the potential to overestimate the extent of noise impact in the community.
  - Alternatively, use the DHV and the posted speed for the highway. Note that depending upon the actual design parameters for a highway, this approach has the potential to underestimate the extent of noise impact in the community.
  - If the DHV is not provided for a highway project, follow procedures in the Highway Capacity Manual to estimate hourly volumes by using the ADT and the K-factor.



**CLOVERLEAF  
INTERCHANGE RAMP**



**DIAMOND  
INTERCHANGE RAMP**

### 3.6.2 Traffic Speed

The operating speed during free flow conditions for the individual roadways should be used for the noise analysis. If there is no data available regarding the operating speed, the posted speed can be used. Interchange ramp speeds will be determined on a case-by-case basis. Typically, 35 mph is used for cloverleaf interchange ramps and 45 mph is used for diamond interchange ramps. The operating speed shall be used if it is determined to be consistently higher than the posted speed limit.

### 3.6.3 Traffic Composition

Three types of vehicles (cars, medium trucks, and heavy trucks) are input into TNM. TNM also accounts for buses and motorcycles; however, traffic data are usually not specific enough to include these vehicle types. Unless the traffic characteristics support the use of these inputs, such as a bus route, buses are typically counted in the medium truck category.

Traffic composition should be obtained from traffic counts. If the composition is not available, typically the total truck percentage would be approximately 10 percent of the ADT.

### 3.6.4 Pavement Type

Four specific pavement types are provided in TNM, including:

- Dense-graded asphaltic concrete (DGAC),
- Portland cement concrete (PCC),
- Open-graded asphalt concrete (OGAC), and
- Average pavement (DGAC and PCC)

The average pavement should be used for all modeling scenarios, including the existing, no-action and build scenarios.

## 3.7 Traffic Noise Level Predictions

### 3.7.1 Prediction of Interior Noise Levels

Primary consideration shall be given to exterior areas where frequent human use occurs. The interior noise criterion is appropriate for determining noise impacts for Activity Category D land uses only where there are no exterior areas of frequent human use or where exterior areas of frequent human use are far from or shielded from the roadway, preventing exterior noise impacts (See Table 2-1).

Interior noise levels shall be used for the evaluation of potential traffic noise impacts only if no exterior use areas are identified for those land uses within Activity Category D. Interior noise levels (with an NAC of 52 dB(A)) also may be evaluated for land uses in Activity Category D when it has been determined that exterior noise abatement measures are not feasible and reasonable. The interior noise level information may be useful when discussing traffic noise impacts for which no feasible or reasonable abatement measure is available.

Interior noise level predictions may be computed by subtracting the building noise reduction factors (See Table 3-2) from the exterior noise levels. Alternatively, if actual measurements of building noise reduction factors are obtained (available) for each building involved or if the building noise reduction factors are calculated from detailed acoustical (sound) analysis for each building involved, the measurements or calculated noise reduction factors should be used. If the measurements or calculations for the involved buildings are not available, then the noise reduction factors provided in Table 3-2 may be used. Generally, the windows shall be considered open unless there is firm knowledge that the windows are in fact kept closed almost every day of the year.

**TABLE 3-2  
BUILDING NOISE REDUCTION FACTORS**

<b>Building Type Structures</b>	<b>Window Condition</b>	<b>Noise Reduction due to Composition of Exterior of the Structures (or 'Structure Type')</b>
All	Open	10 dB
Light Frame	Ordinary Sash (closed)	20 dB
Light Frame	Storm Windows	25 dB
Masonry	Single Glazed	25 dB
Masonry	Double Glazed	35 dB

Source: FHWA Highway Traffic Noise Analysis and Abatement Policy and Guidance, Revised January 2011.

### 3.7.2 Scenarios Evaluated

Scenarios evaluated for the traffic noise assessment include:

- *Existing Condition* – Existing traffic volumes, existing roadway geometry. In cases where there is no existing roadway, noise monitoring shall be used to determine existing noise levels.
- *Proposed No-Action Condition* – Projected traffic volumes (i.e., typically the design year), existing roadway geometry.
- *Proposed Build Condition* – Projected traffic volumes (i.e., typically the design year), proposed roadway geometry.

Traffic noise impacts are determined for the Proposed Build Condition only, as Illinois does not have a Type II program.

### 3.7.3 Comparison to Criteria/Impact Determination

The noise levels predicted by the model should be rounded to the nearest whole number and compared to the NAC to assess impacts for the Proposed Build Condition. Whole numbers are to be used for reporting purposes as the NAC is presented as whole numbers. Additionally, there is no perceptible change in noise levels of tenths of a decibel. Reporting noise levels to the tenth decibel also implies a false sense of accuracy and precision.

### 3.7.4 Documentation

Traffic noise levels should be documented in a *Noise Analysis Technical Memorandum or Report*. A sample outline of a Noise Analysis Report is included in Appendix A.

### 3.7.5 Noise Contours

Traffic noise impacts are determined using specific identified locations of exterior human use activity, such as a patio or park bench. Impacts for developed or permitted areas shall not be reported using contours or the contour function within TNM. Simple estimated traffic noise contours can be useful as a preliminary or screening tool to establish areas and locations for the specific noise sensitive receptor locations. Contouring can be developed using either the TNM noise contour function or by modeling discrete points and interpolating between the defined points.

Noise contours also can be used to depict traffic noise information for undeveloped areas for which no permit has been obtained for development. The traffic noise information for undeveloped areas is to be provided to local officials (e.g., county or municipal officials) within whose jurisdiction the highway project is located. The design year build noise levels should be predicted for the undeveloped lands and the distance from the edge of the nearest travel lane of the highway improvement shall be provided where the noise level approaches the exterior noise abatement criteria in Table 2-1. Contours can be used to depict these distances.

#### **3.7.6 Weigh Stations, Rest Stops, Ride-Share Lots, or Toll Plazas**

Improvements to weigh stations, rest stops, ride-share lots or toll plazas need to be evaluated for traffic noise when the proposed improvement includes a Type I project (such as the construction of a new facility or a substantial change to an existing facility is proposed). These facilities include both mobile and stationary noise sources (i.e., idling trucks, building facility noise sources). Although the FHWA TNM can be used to evaluate mobile noise sources; it also is necessary to determine the contribution of stationary noise sources in the overall noise environment. If they are found to be a contributing factor, a methodology should be developed in coordination with IDOT to determine the existing and future stationary noise levels at these locations. NCHRP Report 791, "Supplemental Guidance on the Application of FHWA's Traffic Noise Model" (HMMH 2014) should be used as a reference when modeling these complex scenarios.

## 4. TRAFFIC NOISE ABATEMENT EVALUATION

The traffic noise analysis is used to predict the location of traffic noise impacts. The traffic noise abatement evaluation is used to identify potential noise abatement measures for the areas identified to be impacted. In addition to the direct benefits of noise abatement, the social, economic and environmental effects also must be considered. Primary consideration is given to exterior locations of residential areas where frequent human activity occurs and reduced traffic noise levels would be beneficial.

Any noise abatement measure must be determined both feasible and reasonable to be considered for implementation. Every effort should be made to achieve the noise reduction design goal (defined in Section 4.2.1.2 as at least 8 dB(A) for at least one benefited receptor). The noise abatement measure also must be considered a prudent expenditure of public funds to be considered reasonable (See Section 4.2.1.2). The following section outlines noise abatement measures when traffic noise impacts have been determined.

### 4.1 Noise Abatement Measures

Whenever practicable, alignment shifts should be considered to reduce future traffic noise levels. If an alignment shift is not practicable, then noise abatement measures shall be considered for each project where the traffic noise analysis has identified traffic noise impacts. The cost of these measures can be included as part of a Type I Federal-aid participating project. The Federal share and type of funding for noise abatement would be the same as that for the overall project.

**At a minimum, noise abatement in the form of noise barriers shall be considered.** The remaining noise abatement measures can be considered as alternative abatement measures for IDOT, but are not required to be evaluated. Abatement measures that can be considered include the following:

- Construction of noise barriers (Section 4.1.1)
- Traffic management measures (Section 4.1.2)
- Alteration of horizontal and vertical alignments (Section 4.1.3)
- Acquisition of property rights for construction of noise barriers (Section 4.1.4)
- Acquisition of undeveloped land for buffer zones (Section 4.1.5)
- Noise insulation (only for Activity Category D) (Section 4.1.6)

The benefits of any noise abatement measure considered for implementation must be evaluated against other social, economic and environmental impacts and the ability to achieve the purpose and need of the project. The following items should be considered as part of the evaluation:

- Noise abatement benefits
- Cost of abatement
- Absolute noise levels
- Change in noise levels



- Development along the highway
- Environmental impacts of constructing abatement measures
- Viewpoints from benefited receptors

#### 4.1.1 Construction of Noise Barriers

The construction of noise barriers should generally be evaluated within highway right-of-way and may consist of earth berms, noise walls, or a combination of these.

Earth berms have been cited to reduce traffic noise by approximately 3 dB(A) more than vertical noise walls of the same height. However, earth berms can require a substantial amount of right-of-way to construct. At least a 3:1 slope on earth berms is required within the right-of-way for maintenance purposes. Combining earth berms with noise walls provides an opportunity to incorporate earth berms up to the height that can be achieved within the available right-of-way. The noise wall can then be constructed on top of the berm to the height necessary to achieve a substantial noise reduction. The berm requires a much greater area to construct as compared to a noise wall, as seen in Figure 4-1.



*Earth Berms*



*Noise Walls*



*Combination of Noise Walls and Earth Berm*

**FIGURE 4-1  
CROSS-SECTIONS OF NOISE WALLS AND BERMS**

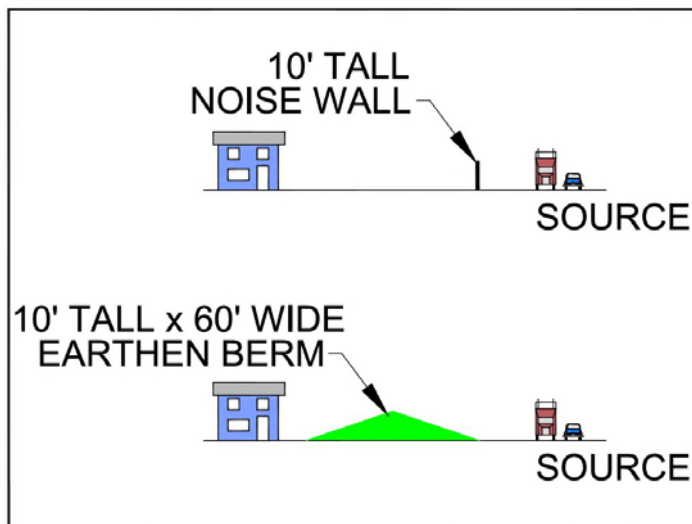

If there are existing noise barriers in the noise study area, please refer to Section 4.2.1.3 for analysis procedures for existing noise barriers.

#### 4.1.2 Traffic Management Measures

This abatement measure includes traffic control devices and the installment of highway signs for prohibition of certain vehicle types, time-use restrictions for certain vehicle types, modified speed limits, and exclusive land designations. Exclusive land designations by local officials may include zoning land adjacent to highways for commercial uses or more noise tolerant uses.

Prohibition of certain vehicle types, such as medium or heavy trucks, or speed restrictions may have adverse impacts on the designated uses of the roadway or create unreasonable hardship on the motoring public or local businesses. Prohibition of commercial vehicular traffic on interstate highways and state marked routes is not permitted by Federal regulations.

Reduction of speed has the potential to reduce traffic noise levels. Generally, a reduction of 20 mph would be needed to reduce the traffic noise level by 5 dB(A). Speed reductions of this magnitude may have adverse impacts on the ability to achieve the purpose of the project, such as increased traffic capacity. Speed limits must adhere to established design guideline and policies.

**Engine Braking** – Noise from engine braking has been identified in some areas as an annoyance. While the prohibition of engine braking may eliminate some of this noise source, it is typically not substantial enough to lower the overall noise level.

#### 4.1.3 Alteration of Horizontal and Vertical Alignments

Adjusting the roadway alignment requires advanced planning. This abatement measure is generally considered for new alignment projects. Movement of the roadway away from a sensitive receptor would be required to reduce traffic noise levels. If all other factors are held constant, every doubling of distance from the noise source typically reduces traffic noise levels between 3 dB(A) (over hard surfaces) and 4.5 dB(A) (over soft surfaces). For example, moving the roadway from 100 feet to 200 feet away from a receptor location would reduce the traffic noise levels between 3 dB(A) and 4.5 dB(A). This assumes flat topography.

Alteration of the vertical alignment would reduce the traffic noise levels if the adjustment were to take advantage of the topographic features or elevated structures. For example, lowering the roadway into a depressed area may provide sufficient shielding to reduce the traffic noise levels.

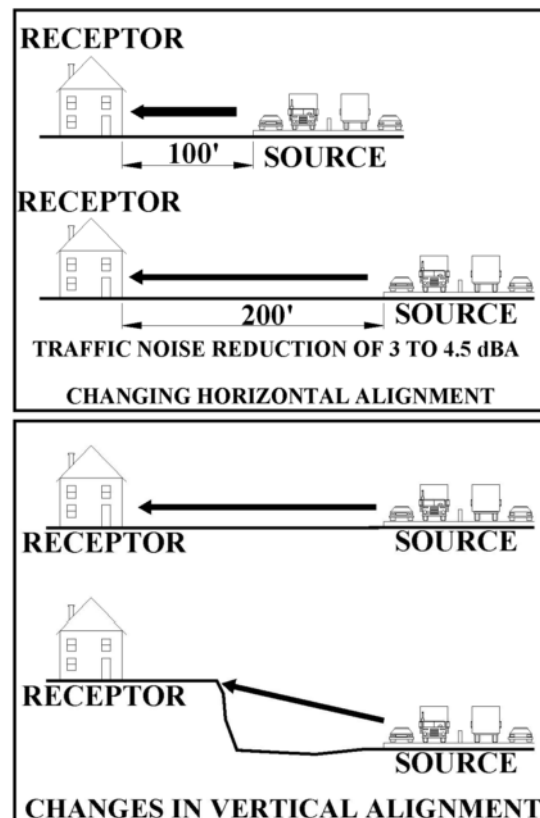

#### 4.1.4 Acquisition of Property Rights for Construction of Noise Barriers

Noise barriers are typically constructed within the right-of-way. Site constraints or limited right-of-way may prohibit the construction of noise walls within existing right-of-way. In this situation, acquisition of additional right-of-way may be undertaken to provide sufficient area to construct a noise barrier.

The cost of right-of-way acquisition for the purpose of noise barrier construction should be included within the cost-effective evaluation of noise abatement if acquisition is needed solely for noise barrier construction. The evaluation of noise walls is presented in Section 4.2, and an example of how right-of-way costs would be included in the cost-effectiveness evaluation is in Table 4-1.

Acquisition of undeveloped land should generally be considered for projects where future proposed improvements are anticipated that may cause impacts. The cost of acquisition should be weighed against the cost of a noise barrier.

**TABLE 4-1  
EXAMPLE: INCLUDING ROW COSTS IN COST EFFECTIVENESS EVALUATION**

Barrier	Benefited Receptors <sup>1</sup>	Noise Wall Cost <sup>2</sup>	ROW Cost Required for Construction of Noise Barrier	Total Noise Wall Cost <sup>2</sup>	Actual Cost per Benefited Receptor	Adjusted Allowable Cost per Benefited Receptor
B1	5	\$158,850	\$0	\$158,850	\$31,770	\$32,000
B2	5	\$127,400	\$197,850	\$300,250	\$65,050	\$30,000

<sup>1</sup> Includes the anticipated outdoor use areas anticipated to receive at least a 5 dB(A) reduction

<sup>2</sup> Based on the IDOT policy value of \$30 per square foot

#### 4.1.5 Acquisition of Undeveloped Land for Buffer Zones

The acquisition of undeveloped land for buffer zones is limited to Type I projects with Federal funding participation. Buffer zones can create compatible land use planning along roadways. This measure primarily relates to the purchase of undeveloped land to preclude future noise impacts. The buffer zone width required to mitigate noise impacts is based on the roadway traffic volumes. It is often not a practical solution due to the width of buffer zone that must be purchased. In many cases, the land along existing roadways is already developed. The purchase of a noise easement is not eligible for Federal-aid participation.

#### 4.1.6 Noise Insulation

Per FHWA (FHWA 2011), highway agencies may only consider noise insulation for public use or nonprofit institutional structures, e.g., places of worship, schools, hospitals, libraries, etc. "Public use or nonprofit institutional structures" means the facility is open for public use, owned by the public or that a nonprofit organization owns the facility.

Insulating buildings can greatly reduce highway traffic noise. Sometimes, this involves installation of sound absorbing material in the walls of a new building during construction. Noise insulation is normally limited to public use structures such as places of worship, schools, and hospitals. Any recommended noise insulation will be coordinated with FHWA.

This measure can be considered for Activity Category D land use facilities listed in Table 2-1 where there are no exterior areas with frequent human use or where areas of frequent

use are shielded from receiving noise impacts and an impact has been determined based on the interior noise impact evaluation (Section 3.7.1).

The noise abatement evaluation for impacted Activity Category D land use facilities based on the interior NAC should first be evaluated using noise barriers. Noise insulation will only be considered for Activity Category D if noise barriers are determined to be not feasible or not reasonable and there is a noise impact based on an interior evaluation. If the only reason the noise barrier is not considered reasonable is due to the outcome of the solicitation of benefited receptor viewpoints, the consideration of noise insulation should be discussed with the IDOT Noise Specialist and FHWA.

As an example, if a noise barrier is determined to be feasible, and achieves the reasonableness criteria of the noise reduction design goal and the cost-effective evaluation, the desire of the benefited receptors will be solicited. If the overall viewpoint indicates a desire for the noise barrier, the noise barrier will be recommended for implementation. However, if the receptor viewpoints indicate an overall lack of desire for the noise barrier, noise insulation will only be considered as a possible noise abatement measure on a case-by-case basis. Noise insulation measures should be discussed with IDOT and FHWA during project development or at coordination meetings.

The cost of noise insulation may be included in Federal-aid participating project costs with the Federal share being the same as that for the system on which the project is located. Estimated build costs for noise insulation shall be developed on a project specific basis. Post-installation maintenance and operational costs for noise insulation are not eligible for Federal-aid funding. Noise insulation will be deemed cost-effective using the same cost reasonableness evaluation used for noise barriers.

## **4.2 Noise Barriers**

Noise barriers are typically the most practical noise abatement measure due to their cost effectiveness and ability to be implemented on right-of-way and along existing roadways. Noise barriers include noise walls, earth berms or a combination of both. Noise barriers reduce noise levels by impeding transmission of noise, absorbing noise or reflecting it back toward the noise source. Noise that still reaches a receptor has been either transmitted through the noise barrier or forced to take a longer path to reach the receptor than if no barrier were present.

Abatement measures such as traffic management, alteration of alignment or purchase of land for use as a buffer zone usually do not provide substantial noise reductions or are not found to be feasible and reasonable due to cost, right-of-way requirements or do not meet the purpose and need of the proposed project. While these are viable noise abatement measures for Federal-aid participation Type I projects, noise barriers are the only abatement measure that is required to be evaluated when impacts are identified. The criteria presented herein are therefore presented in the context of noise barriers, but also would apply to other noise abatement measures, including noise insulation, if they are proposed for implementation as part of the project.

### **4.2.1 Noise Barrier Evaluation Criteria**

IDOT policy identifies general criteria that must be met before a noise barrier shall be recommended for implementation. These include the following:

- Noise barriers shall be evaluated to address the identified traffic noise impacts;

- Noise barriers shall be feasible (can be built and can achieve the traffic noise reduction feasibility criterion of at least 5 dB(A) for at least two **impacted** receptors);
- Noise barriers shall achieve the noise reduction design goal of at least 8 dB(A) for at least one **benefited** receptor (Reasonableness Criterion 1);
- Noise barriers shall be cost effective (i.e., may not exceed the allowable noise abatement cost) (Reasonableness Criterion 2); and
- Noise barriers shall be deemed desired by the benefited receptors (Reasonableness Criterion 3).

The process of the noise abatement analysis is illustrated in a flowchart in Figure 4-2.

**FIGURE 4-2  
NOISE ABATEMENT ANALYSIS PROCEDURES**

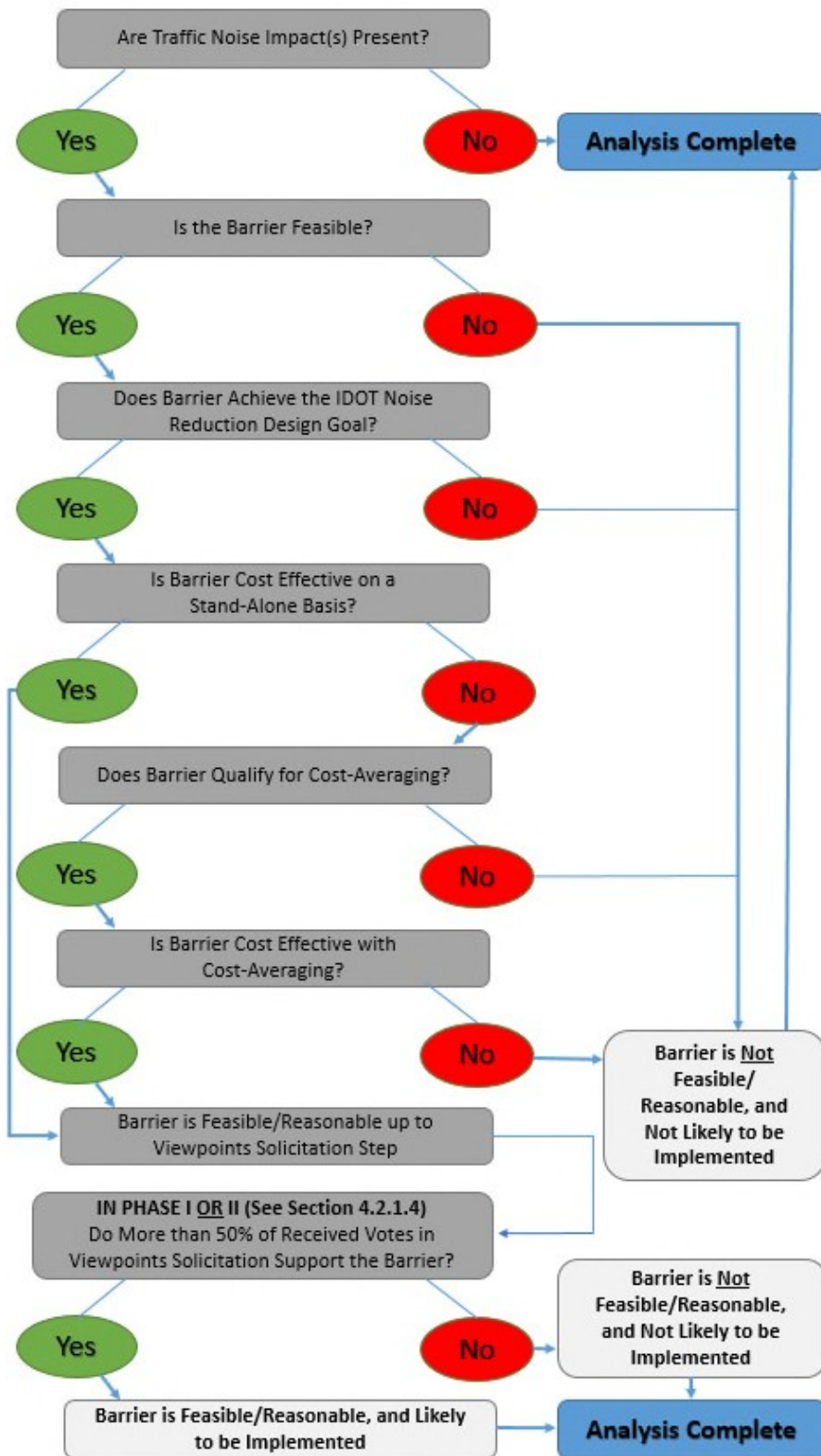

#### 4.2.1.1 Feasibility

Feasibility generally addresses the engineering aspects of implementing a noise barrier. This includes considerations for safety, drainage, and utilities, which are discussed further in Section 4.2.7. A noise abatement measure must achieve the traffic noise reduction feasibility criterion of at least 5 dB(A) for at least two impacted receptors for it to be considered a feasible noise abatement measure. The objective is not to just reduce traffic noise levels below the NAC.

**Traffic Noise Reduction Feasibility Criterion** – The objective of the traffic noise abatement evaluation is to obtain a perceptible traffic noise reduction (5 dB(A) or more) for at least two impacted receptors. The objective is not to reduce traffic noise levels below the NAC.

Consequently, a noise barrier evaluated for an Activity Category B or C impacted receptor with a projected traffic noise level of 68 dB(A) should reduce the noise level to at least 63 dB(A), not 66 dB(A). A reduction of 2 dB(A) from 68 dB(A) to 66 dB(A) would not be a perceptible change in noise levels and therefore not a prudent expenditure. Similarly, a noise wall providing abatement to a receptor with a projected traffic noise level of 76 dB(A) would be designed to reduce noise levels to at least 71 dB(A). While still greater than the NAC, this noise wall would be considered feasible as it achieves the traffic noise reduction feasibility criterion.

In most situations, noise abatement provided for exterior areas (i.e., a noise barrier) also will mitigate interior areas. If an interior noise impact is identified, the first abatement measure to be considered should be the same as for exterior noise impacts. Sound insulation shall only be considered on a case-by-case basis for Activity Category D land use facilities, after all other abatement measures have been deemed not feasible or reasonable. If the noise barrier is determined to be reasonable and feasible, it would be recommended for implementation. If the noise barrier was not determined to be feasible or reasonable, then other abatement measures may be considered (i.e., sound insulation for Activity Category D land use) on a case-by-case basis.

#### 4.2.1.2 Reasonableness Criterion 1: Noise Reduction Design Goal

The reasonableness evaluation for noise abatement consists of three parts: the noise reduction design goal, cost effectiveness and the viewpoints of the benefited receptors. Each component of the reasonableness evaluation is presented below.

The noise reduction design goal requires at least an 8 dB(A) traffic noise reduction for at least one benefited receptor location. While the receptor achieving the noise reduction design goal does not need to be an impacted receptor, in most scenarios, they may be the same. The noise reduction design goal should be achieved for as many receptors as possible while still achieving the cost effectiveness criterion.

### 4.2.1.3 Reasonableness Criterion 2: Cost Effectiveness

The cost-effective evaluation of the noise barrier considers the overall cost of the noise barrier, the number of benefited receptors, and the cost per benefited receptor.

#### Overall Noise Wall Cost

The estimated build cost for noise barriers should be determined using the current standard unit cost approved by IDOT. The current unit cost used by IDOT to determine the estimated build cost for noise barriers is \$30 per square foot. This unit cost is based on actual IDOT Phase III construction costs (materials and installation) and engineering design. The cost of right-of-way acquisition for the purpose of noise barrier construction also should be included if acquisition is needed solely for noise barrier construction. This unit cost and the allowable cost will be evaluated every five years by IDOT and will be based on actual construction costs. Estimated build costs for other noise abatement measures being evaluated should be based on preliminary engineering cost estimates.

#### TNM Tip

TNM typically provides the total noise wall area and cost if the unit noise wall cost is input into the noise barrier input. The area calculations made by TNM should be checked for accuracy.

The area of a noise wall is based on the noise wall length and height. A staggered noise wall height will require calculating the area for each noise wall section. The total noise wall area is the summation of the area of all wall sections. Calculation of an earth berm's area is not as direct, and depends upon the design of the barrier. Cost of berms should be calculated on a case-by-case basis.

#### Number of Benefited Receptors

A benefited receptor is considered any sensitive receptor (see Section 3) that receives at least a 5 dB(A) traffic noise reduction as a result of the noise barrier, regardless of whether the receptor was identified as impacted. As an example, a single-family residence would be considered one benefited receptor if it receives at least a 5 dB(A) traffic noise reduction. In the case of multi-unit dwellings (i.e., condominiums, townhouses, apartments and duplexes), each unit should be counted as one receptor.

#### Residential Benefited Receptors

The evaluation of residential receptors requires the prediction of the number of benefited residences that would be afforded at least a 5 dB(A) traffic noise reduction. For single-family residences, each house represents one benefited receptor. For multi-family residences, each living unit (i.e., apartment) afforded at least a 5 dB(A) traffic noise reduction would represent one benefited receptor. A unit also can be considered benefited if the residents of that unit have access to an exterior common use area that would receive a 5 dB(A) traffic noise reduction. While it is not the objective of the noise abatement design to mitigate above the ground floor locations, in certain circumstances, such as when the roadway is elevated and the second floor is level with the roadway, second floor units can be counted as benefited receptors if the noise barrier provides at least a 5 dB(A) traffic noise reduction at the second floor elevation (See Section 3.4.1).



**Non-Residential Land Uses (Potential Benefited Receptor Units)**

The number of benefited receptors for various receptors requires consideration of the type of units benefited. Generally, the primary focus of the evaluation is to reduce traffic noise levels for frequent human use outdoor areas. Table 3-1 provides guidance for locations for evaluating potential benefited receptors.

**Cost Effectiveness Determination**

The estimated build cost of each noise abatement measure may not exceed the allowable noise abatement cost based on a cost per benefited receptor comparison. The base value for the allowable noise abatement cost is \$30,000 per benefited receptor. The estimated build cost of noise abatement per benefited receptor is determined by dividing the overall estimated build cost by the number of benefited receptors.

Other reasonableness factors shall be considered to potentially adjust the allowable noise abatement base value cost of \$30,000 per benefited receptor to account for project-specific factors. Consideration of additional factors can be used to adjust the allowable noise abatement base cost of \$30,000 per benefited receptor. These three additional factors include:

- the absolute noise level of the benefited receptors in the design year build scenario before noise abatement;
- the incremental increase in noise level between the existing noise level at the benefited receptor and the predicted build noise level before noise abatement; and
- the date of development compared to the construction date of the highway.

The base value of \$30,000 per benefited receptor will be adjusted considering these three factors based on Table 4-2. Only one value from each of the three factors may be used for each receptor, resulting in a potential maximum allowable noise abatement cost of \$45,000 per benefited receptor. If the estimated build cost of noise abatement per benefited receptor is less than the adjusted allowable noise abatement cost per benefited receptor, then the noise abatement measure achieves the cost-effective reasonableness criterion.

**TABLE 4-2**  
**FACTORS FOR ADJUSTING THE ALLOWABLE NOISE ABATEMENT COST PER**  
**BENEFITED RECEPTOR BASE VALUE OF \$30,000 USING OTHER REASONABLENESS**  
**FACTORS**

**Absolute Noise Level Consideration**

Predicted Build Noise Level Before Noise Abatement	Dollars Added to Base Value Cost per Benefited Receptor
Less than 70 dB(A)	\$0
70 to 74 dB(A)	\$1,000
75 to 79 dB(A)	\$2,500
80 dB(A) or greater	\$5,000

**Increase in Noise Level Consideration**

Incremental Increase in Noise Level Between the Existing Noise Level and the Predicted Build Noise Level Before Noise Abatement	Dollars Added to Base Value Cost per Benefited Receptor
Less than 5 dB(A)	\$0
5 to 9 dB(A)	\$1,000
10 to 14 dB(A)	\$2,500
15 dB(A) or greater	\$5,000

**New Alignment / Construction Date Consideration**

Project is on new alignment OR the receptor existed prior to the original construction of the highway	Dollars Added to Base Value Cost per Benefited Receptor
No for both	\$0
Yes for either	\$5,000

**Note:** No single optional reasonableness factor shall be used to determine that a noise abatement measure is unreasonable.

A detailed example of the evaluation is provided in Appendix C. The following is a brief example of a cost effectiveness analysis based on a noise wall benefiting 10 receptors.

*Assume the build noise level for all receptors is 70 dB(A), the increase in noise between existing and build scenarios is 6 dB(A), and that all homes were built after the original highway was constructed.*

*Area of noise wall = 1,015 ft. long x 10 ft. high = 10,150 sq. ft.*

*Estimated build cost of noise wall = 10,150 sq. ft. x \$30 per sq. ft. = \$304,500*

*Estimated build cost per benefited receptor = \$30,450 / benefited receptor*

*Base allowable cost per benefited receptor = \$30,000 / benefited receptor*

The adjustment factors are then added to each of the benefited receptors individually, as detailed in Table 4-3 below.

**TABLE 4-3  
EXAMPLE: COST EFFECTIVENESS ANALYSIS**

Benefited Receptor Number	Build Noise Level, dB(A)	Increase in Noise, Existing to Build, dB(A)	Homes Built Before Roadway, Yes/No	Absolute Noise Level Adjustment Factor	Increase in Noise Adjustment Factor	New Alignment / Const. Date Adjustment Factor	Cumulative Reasonableness Adjustment Factors	Total Adjusted Allowable Cost per Receptor
R1-1	69	4	No	\$0	\$0	\$0	\$0	\$30,000
R1-2	72	4	No	\$1,000	\$0	\$0	\$1,000	\$31,000
R1-3	71	5	No	\$1,000	\$1,000	\$0	\$2,000	\$32,000
R1-4	73	6	No	\$1,000	\$1,000	\$0	\$2,000	\$32,000
R1-5	74	7	No	\$1,000	\$1,000	\$0	\$2,000	\$32,000
R1-6	75	6	No	\$2,500	\$1,000	\$0	\$3,500	\$33,500
R1-7	73	7	No	\$1,000	\$1,000	\$0	\$2,000	\$32,000
R1-8	71	6	No	\$1,000	\$1,000	\$0	\$2,000	\$32,000
R1-9	71	4	No	\$1,000	\$0	\$0	\$1,000	\$31,000
R1-10	69	4	No	\$0	\$0	\$0	\$0	\$30,000
Average for Entire Noise Barrier				\$950	\$600	\$0	\$1,550	\$31,550

Final adjusted allowable cost per benefited receptor = \$31,550 / benefited receptor

In this example, the estimated build cost per benefited receptor (\$30,450) is less than the adjusted allowable cost per benefited receptor (\$31,550) and therefore achieves the economic reasonability criterion. The example assumes that at least two impacted receptors achieve a 5 dB(A) traffic noise reduction to be considered feasible and at least one of the benefited receptors achieves at least an 8 dB(A) traffic noise reduction to achieve the noise reduction design goal.

The noise wall evaluation for this example also should investigate the possibility of modifying the noise wall configuration to determine if additional receptors could become benefited or if additional traffic noise reductions could be provided to those receptors already considered benefited. Types of modifications may include extending noise walls, changing the height, or moving the location of the wall. **Generally, a proposed noise abatement measure should provide traffic noise reductions to as many impacted receptors as possible and provide as much noise reduction as possible while remaining within the economic reasonability criterion.**

In some situations, achieving at least an 8 dB(A) traffic noise reduction at all impacted receptors may not achieve the cost effective evaluation as presented in this section. Alternative noise barrier heights and lengths should be considered such that at least one benefited receptor behind the noise barrier achieves the 8 dB(A) traffic noise reduction. If the remaining receptors are still afforded at least a 5 dB(A) traffic noise reduction, they would still be considered benefited receptors (defined as experiencing at least a 5 dB(A) reduction in noise due to abatement measures). Alternative noise barrier configurations

should be considered in an effort to abate as many receptors as possible while remaining within the cost effective criterion.

### Cost Averaging

Cost averaging of noise abatement among common noise environments (CNEs) may be used when conducting the reasonableness evaluation. For a single noise abatement measure to be considered as part of a cost averaging evaluation, the estimated build cost of noise abatement per benefited receptor may not exceed two times the adjusted allowable noise abatement cost per benefited receptor.

Using the previous example provided to demonstrate the reasonableness factors, the estimated build cost per benefited receptor was \$30,450, which was less than the adjusted allowable cost per benefited receptor of \$31,550. This noise wall can therefore be included in the cost averaging approach. In this example, the CNE could be part of the cost averaging calculation as long as the estimated build cost was \$63,100 or less (\$31,550 per benefited receptor multiplied by 2).

Noise abatement measures achieve the cost reasonableness criterion if the common CNE collective average estimated build cost of noise abatement per benefited receptor is less than the collective average adjusted allowable cost per benefited receptor. For purposes of the cost averaging approach, it is recommended to base the determination on the weighted average for both the estimated build cost of noise abatement and the adjusted allowable cost per benefited receptor. The following is a simple example of the process. A more detailed example is provided in Appendix C.

*After each CNE has been evaluated independently, the CNEs are ranked in order of increasing ratio of the estimated build cost per benefited receptor to the adjusted allowable cost per benefited receptor. This method ranks them in order of increasing cost effectiveness based on the ability to achieve the economic reasonability criterion. The CNEs with ratio values greater than 2.0 are removed from the evaluation, as these will be the ones for which the estimated build cost is more than double the adjusted allowable cost per benefited receptor.*

*Once the CNEs are in order of increasing ratio of the estimated build cost per benefited receptor to the adjusted allowable cost per benefited receptor, the cumulative cost per benefited receptor is calculated for both the estimated build cost and the adjusted allowable cost.*

*In the scenario in Table 4-4, based on the cumulative costs, noise walls for CNEs 8, 2, 1 would be cost-effective on a standalone basis, and CNE 3 would achieve the cost effective evaluation on a cumulative basis, as the cumulative estimated build cost per benefited receptor (\$30,796) is less than the cumulative adjusted allowable cost per benefited receptor (\$34,007). The build cost for the next noise walls (CNE 7 and CNE 6) exceed the allowable cost and therefore would not be recommended for implementation as part of the proposed project. CNE 5 and CNE 6 were removed from the evaluation because their ratio values were greater than 2.0.*

**TABLE 4-4  
EXAMPLE: COST AVERAGING TABLE**

CNE No.	Number of Benefited Receptors	Noise Wall Cost	Estimated Build Cost per Benefited Receptor	Adjusted Allowable Cost per Benefited Receptor	Ratio of Est. Build/ Adjust. Allowable	Cumulative Estimated Build Cost/Benefited	Cumulative Adjusted Allowable Cost/Benefited	Result of Determination
(A)	(B)	(C)	(D) = (C) / (B)	(E)	(F) = (D) / (E)	(G)	(H)	(I)
8	40	\$962,500	\$24,063	\$32,000	0.75	\$24,063	\$32,000	Cost-Effective Stand Alone
2	155	\$4,200,000	\$27,097	\$35,000	0.77	\$26,474*	\$34,385**	Cost-Effective Stand Alone
1	45	\$1,600,000	\$35,556	\$37,000	0.96	\$28,177	\$34,875	Cost-Effective Stand Alone
3	52	\$2,230,000	\$42,885	\$30,000	1.43	\$30,796	\$34,007	Cost-Effective Cumulative
7	42	\$2,400,000	\$57,143	\$32,000	1.79	\$34,109	\$33,754	Not Cost-Effective
6	2	\$132,500	\$66,250	\$35,000	1.89	\$34,301	\$33,762	Not Cost-Effective
5	2	\$145,000	\$72,500	\$35,000	2.07	Not part of evaluation as estimated cost is more than 2 times the adjusted allowed cost		Not Cost-Effective
4	12	\$962,500	\$93,750	\$36,000	2.60			Not Cost-Effective

\*  $(\$24,063 \times 40 + \$27,097 \times 155) / (40 + 155) = \$26,474$

\*\*  $(\$32,000 \times 40 + \$35,000 \times 155) / (40 + 155) = \$34,385$

COLUMN G General Equation (Column Letter Row Number):  $(E_1 \times B_1 + E_2 \times B_2 \dots + E_x \times B_x) / (B_1 + B_2 \dots + B_x)$

COLUMN H General Equation (Column Letter Row Number):  $(D_1 \times B_1 + D_2 \times B_2 \dots + D_x \times B_x) / (B_1 + B_2 \dots + B_x)$

### Third Party Funding

Third party funding is not allowed on a Federal or Federal-aid project if the noise abatement measure would require the additional funding from the third party to be considered feasible and/or reasonable. Third party funding is acceptable on Federal or Federal-aid highway projects to make functional enhancements to a noise abatement measure already determined feasible and reasonable. Third party funding infrequently occurs for Federal projects, and is assessed by FHWA and IDOT on a case-by-case basis.

### Assessing Feasibility and Reasonableness of Modifying Existing Noise Barriers

The presence of an existing noise barrier or earth berm complicates noise analyses for new Type I projects per IDOT noise policy. The modeling of existing noise, in an attempt to represent the existing noise environment, must include any existing solid barrier of considerable mass designed specifically to abate noise; therefore, existing noise levels that are calculated include any existing barriers in the model.

Another challenging issue regarding existing noise barriers is identifying and mitigating potential noise impacts associated with a new Type I project. Each existing noise barrier was specifically designed for noise mitigation based on conditions when that barrier's previous project was conducted. As a result, the noise analysis for a new Type I project should consider the effectiveness of existing noise barriers and consider whether they require retrofit or modification based on the new Build conditions.

When an existing noise barrier is not physically impacted or relocated as part of a new Type I project and impacts are identified, the noise analyst shall determine if modification of the existing noise barrier is feasible and reasonable for the mitigation of additional impacts related to the new build condition. The noise analyst will determine the design year noise levels with and without modification of the existing noise barrier. Should modification of the

existing noise barrier be determined not feasible or not reasonable as defined in current policy, the existing noise barrier will be left in place without modification.

Two scenarios involving existing noise barriers are most likely to be encountered during new Type I projects:

**Scenario 1:** When an existing noise barrier is physically impacted or relocated as part of a new Type I project, at a minimum, the same attenuation line or barrier height must be provided where physically feasible. Changes in the dimensions of the replacement noise barrier that provides the same attenuation line shall not be subject to the reasonableness criterion if the site conditions require such modification (e.g., if the height of a noise barrier must be increased to maintain the attenuation line if the barrier moved down a slope). Similarly, if a proposed project relocates a barrier upslope, the same height of the barrier above ground must be maintained. Should additional modifications to the noise barrier beyond this required replacement be feasible to protect additional receptors impacted as a result of the Type I improvement, these modifications would be subject to the cost-effectiveness criterion as in Scenario 2 below.

**Scenario 2:** When an existing barrier is not physically impacted by the project (but the project creates noise impacts that the existing barrier does not completely address) any modifications to the noise barrier to address the impacts associated with the Type I improvement would be subject to the cost-effectiveness criterion. For example, if a 16-foot noise barrier is a feasible modification of a 10-foot noise barrier, then only the 6 additional feet would be subject to the reasonableness criteria. A benefited receptor would be defined as those receptors that receive an additional 5 dB(A) reduction or greater from the additional barrier height.

#### 4.2.1.4 Reasonableness Criterion 3: Viewpoints of Benefited Receptors

The third component of reasonableness is obtaining the viewpoints of benefited receptors either during Phase I or Phase II Design.<sup>4</sup> The viewpoints of benefited receptors shall be solicited for noise abatement measures (e.g., noise barriers) determined to be feasible, achieving the noise reduction design goal, and cost effective. The viewpoints of benefited receptors shall be solicited to determine their desire for implementation of the noise abatement measure. Benefited receptors include property owners (including non-residential properties) **and** renters/leasers residing on the benefited property.

FHWA states that there are several methods of viewpoints solicitation and public outreach (Question G7 of FAQ, FHWA 2015). Each project can consider voting methods on a case-by-case basis with the Districts and the Bureau of Design and Environment. A common method employed for viewpoints solicitation is using voting packets mailed to each benefited receptor that may include a cover letter explaining the project and the voting process, a plan view of the proposed barrier, and a voting form with space for additional public comments. Other methods suggested by FHWA include public meetings, surveys, community group meetings, etc. Secure voting by unique voter identification may be employed on a case-by-case basis at the discretion of the Districts and the Bureau of Design and Environment.

Regardless of when the viewpoints solicitation occurs in the project development process or the method of how votes are solicited, the desire is to obtain as many vote responses as possible. The goal is to obtain responses from at least one-third (33%) of the potential

---

<sup>4</sup> Decisionmaking guidelines to determine if a project should have Phase I or Phase II voting are noted later in this section of the handbook.

number of votes for each noise abatement measure (i.e., for each noise barrier being considered). If responses from one-third of the potential votes cast for a given wall are not received after the first attempt, a second attempt shall be made. The Districts may consider delivering the second attempt for viewpoint solicitation by certified mail or other form of certified delivery, at their discretion. The voting result can be determined after viewpoints from at least one-third of the potential votes have been received or after two attempts have been made to obtain the responses. ***If after the second attempt there are still less than one-third of the potential votes received, the voting result will be determined based on the responses received.***

Once the responses have been collected, the viewpoints must be tallied. In order for a proposed noise abatement measure to be implemented, greater than 50% of the votes from votes responding must be in favor of the proposed abatement measures. If no votes are received, no barrier will be recommended for construction. Viewpoints will be tallied for each individual abatement measure (i.e., for each noise barrier being considered). A response from front row benefited receptors (receptors or properties adjacent to a proposed barrier, as illustrated in Figure 4-3) will be counted and weighted compared to non-front row receptor responses, as shown in Table 4-5. Front row receptor status will be reviewed with IDOT on a case-by-case basis. If no votes are received, the barrier will not be recommended for construction.

**FIGURE 4-3  
EXAMPLES: FRONT ROW RECEPTORS**

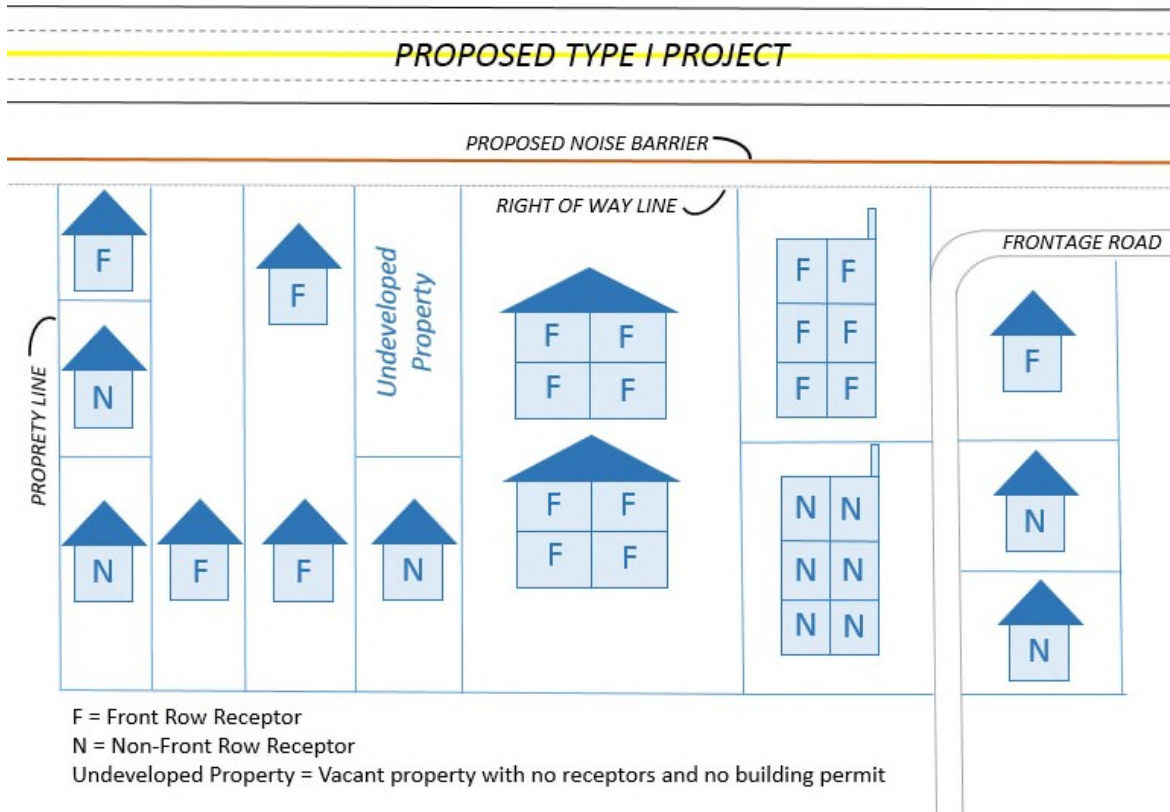

**TABLE 4-5  
NUMBER OF VOTES PER BENEFITED RECEPTOR**

<i>Receptor Location</i>	<i>Rental Property</i>		<i>Owner Occupied Property: Number of Votes Per Unit</i>
	<i>Owner: Number of Votes Per Unit</i>	<i>Renter: Number of Votes Per Unit</i>	
Front Row	2	2	4
Non-Front Row	1	1	2

The purpose of providing more weight to the front row receptors is to give them additional consideration for the proposed noise barriers.

The proposed abatement measures will be presented as likely to be implemented (provided they are deemed feasible and reasonable for noise reduction and cost-effectiveness) as part of the public involvement process to determine if the benefited receptor viewpoints support the noise abatement measure implementation. The following is an example of the process. A more detailed example is provided in Appendix C.

As an example, there were 10 owner-occupied benefited receptors used in the cost-effective evaluation example. Six are front row (6 x 4 = 24 votes) and four are non-front row



(4 x 2 = 8 votes) for a total of 32 potential votes. The goal would be to obtain responses that total at least 11 votes (at least 33%) from the 10 benefited receptors. If at least 11 votes are received and greater than 50% of these votes are in favor of the noise abatement measure, it will be recommended for implementation. The noise abatement measure would not be recommended for implementation if there were not greater than 50% of votes that were in favor of the noise abatement measure.

Below is a letter template that Districts may use as the first attempt to obtain the viewpoints from benefited receptors. If a second attempt is required due to insufficient responses from the first attempt, a modification of this letter can accomplish that effort.

*(Date) (Name) (Address)*

Re: Viewpoint Solicitation – First Notice

Noise Barrier Implementation

*(Project Name) (Project Limits)*

Dear *(Property Owner or Resident Name)*:

The Illinois Department of Transportation (IDOT) is conducting Preliminary Engineering and Environmental (Phase I) studies for (project name). The purpose of the (project name) study is to (project description).

As part of the environmental studies for this project, traffic noise was evaluated for the proposed improvements as well as the No-Build, or do-nothing option. The analysis found that with the proposed improvements, the predicted future noise levels in your area justify the installation of a noise wall. Based on this study, a noise wall is recommended in your area. The enclosed exhibit shows the location of the noise wall and lists the approximate length and height.

IDOT takes public opinion into account before a final decision is made on the construction of noise walls. Each property “benefited” by a noise wall may vote in favor of or against the wall. A property is benefited by a wall when the proposed wall results in a noticeable reduction in noise level, which is defined as five decibels or more. If more than half of the votes received are in favor of the wall, the wall will likely be included in the project. A final decision on the installation of the wall will be made upon completion of the project’s final design and the public involvement process.

Your property/rental unit has been found to be benefited from the noise wall shown in the enclosed exhibits. IDOT respectfully requests your vote for or against the noise wall.

Additional information can be found in IDOT’s Traffic Noise Assessment Manual, which is available online.

Enclosed is a “Viewpoint Form” for you to vote for or against the recommended noise wall in your area. For your vote to count, please complete and return the form by (deadline date) using the provided self-addressed, stamped envelope. If you have any questions or need additional information, please contact me or (Project Manager Name), Project Manager, at (Phone Number).

Very truly yours,

### Timing of Viewpoints Solicitation in the Project Development Process

***The viewpoints solicitation may occur in either Phase I Preliminary Engineering and Environmental or in Phase II Design.*** Per FHWA, the solicitation of viewpoints should occur following approval of the final noise abatement design, which would mean voting would best occur in Phase II (Question G8 of the FAQ, FHWA 2015). Viewpoints solicitation in Phase II presents a fully realized noise barrier design and aesthetic for voting. However, some circumstances support an earlier vote during Phase I, either due to a short project timeframe or Phase I reporting that would require an earlier recommendation on the inclusion of noise barriers in a project. *The final determination on when to hold viewpoints solicitation will be left to the IDOT District and the Bureau of Design and Environment, on a case-by-case basis. It is recommended that the timing of viewpoints solicitation be made based on the following factors:*

- If a project involves a Section 106 (historic) property, the entire project is recommended to have viewpoints solicitation voting in Phase I to fulfill Section 106 process requirements in Phase I.
- If a project has funding beyond Phase I included in IDOT's five-year plan (Proposed Highway Improvement Program), voting can occur in Phase I due to the short timeframe prior to design.
- If a project does not have funding beyond Phase I included in IDOT's five-year plan, voting should occur in Phase II due to the long term nature of the project.

If voting occurs in Phase I, the following general procedures are recommended. Specific decision making for each project should be made by the Districts and the Bureau of Design and Environment on a case-by-case basis.

- Complete the majority of the traffic noise report for the project prior to viewpoints solicitation, but do not finalize.
- Include a proposed schedule for Phase I viewpoints solicitation in project timeframes for public outreach purposes. If a project is determined by the District/BDE to require a noise forum (public meeting summarizing the proposed barriers that will be voted upon in viewpoints solicitation), the forum should be scheduled prior to the viewpoints solicitation period.
- Prepare a mailing list for benefited properties (owners and renters) by barrier.
- Prepare and have IDOT approve the viewpoints solicitation package using Phase I design level information.
- Conduct one or two rounds of viewpoints solicitation, based upon response, and tabulate results by barrier.
- Summarize findings from viewpoints solicitation in the finalized traffic noise report for the project, which should identify the barriers likely to be implemented, as well as top of barrier elevations for the barriers likely to be implemented.

If voting occurs in Phase II, the following general procedures are recommended. Specific decision making for each project should be made by the Districts and the Bureau of Design and Environment on a case-by-case basis.

- Finalize the traffic noise report for the project in Phase I, identifying all noise barriers that are feasible, meet the noise reduction design goal (NRDG), and are cost effective. Conclude the report by identifying the barriers for which viewpoints solicitation would occur in Phase II, as well as the top of wall elevations for all

barriers up for viewpoints solicitation in Phase II. There shall be a commitment placed in the NEPA document indicating that viewpoints solicitation will occur in Phase II Design.<sup>5</sup> Since voting will not occur during Phase I, the statement of likelihood in the noise analysis report and related conclusions in the NEPA document should include a disclosure that the solicitation of viewpoints will occur during the completion of the project's final design and the public involvement processes.<sup>6</sup>

- Include a proposed schedule for Phase II viewpoints solicitation in project timeframes for public outreach purposes.
- In Phase II, prepare a mailing list for benefited receptors (owners and renters) by barrier.
- In Phase II, determine wall design and material details in preparation for viewpoints solicitation.
- In Phase II, conduct public outreach prior to the viewpoints solicitation so the public can obtain information about the proposed barriers that will be voted upon.
- In Phase II, prepare and have IDOT approve the viewpoints solicitation package using Phase II design information, including recommended wall design and materials details.
- Conduct one or two rounds of Phase II viewpoints solicitation, based upon response, and tabulate results by barrier.
- After Phase II viewpoints solicitation, summarize findings from viewpoints solicitation in a supplemental memorandum to the Phase I traffic noise report for the project. The supplemental report should identify the barriers likely to be implemented, as well as top of barrier elevations for the barriers likely to be implemented.

#### 4.2.2 Noise Barrier Materials

Noise barriers in Illinois have been constructed of earth, masonry, concrete, and composite materials. These barrier materials must meet certain transmission loss characteristics.

Alternative noise barrier materials and/or designs may be considered by IDOT and FHWA Illinois Division on a case-by-case basis. Any proposed alternative noise barrier must meet IDOT specifications, notably the transmission loss specification. Local cost sharing may be required for projects involving alternative noise barrier materials that exceed the IDOT typical noise wall cost of \$30 per square foot.

#### Density

Earth berms, due to their inherent thickness and material, are sufficiently dense to effectively reduce noise transmission. Other types of noise barrier materials must be of sufficient density (typically four pounds per square foot minimum) to be able to effectively reduce sound transmission through the barrier. Since density will vary for different materials, the transmission loss characteristics of a material must be tested before further testing protocol required by IDOT is considered.

---

<sup>5</sup> See Section 6.2

<sup>6</sup> See Section 6.2

## **Transmission Loss**

Transmission loss is the sound level reduction provided by a material as sound passes through it. Noise wall materials are required to achieve a sound transmission loss equal to or greater than 20 dB in all one-third octave bands from 100 hertz to 5,000 hertz, inclusive. Noise wall manufacturers are required to provide this data to IDOT before further testing protocol is considered. Specialty items and materials that are not covered by ASTM, AASHTO, or other IDOT specifications must have the prior approval of the Illinois Highway Development Council (IHDC). Contact the Engineer of Technical and Product Studies at the Bureau of Materials and Physical Research for additional information on the IHDC process.

## **Noise Reduction Coefficient (NRC)**

Noise walls are typically identified as either absorptive or reflective (non-absorptive). The absorptive capacity of the wall material is specified by the NRC, which can range from 0.00 to 1.00, with 1.00 representing 100 percent absorption. To be considered absorptive by IDOT, the NRC must be at least 0.80 on the roadway side of a noise wall and at least 0.65 on the side of the wall away from the roadway.

### **4.2.3 Noise Barrier Location**

#### **Barrier Location on Right-of-Way**

The construction of noise barriers is typically within highway right-of-way. Noise barriers are most effective when located close to the receptor or close to the noise source. While both options can be considered, the location of the noise barrier along the right-of-way typically provides sufficient open space between the roadway and noise barrier to satisfy clear zone requirements. It also allows for maintenance access and does not require additional land acquisition. Therefore, locating noise barriers within the highway ROW is generally preferable. Noise barriers located along the roadway typically require safety features such as guardrails or jersey barriers to satisfy safety requirements (See Section 4.2.7). Sight distance or safety requirements also need to be considered to ensure they are feasible. These issues should be discussed at District coordination meetings.

#### **Barrier Location off Right-of-Way**

Noise barrier lengths may be reduced in some cases if the noise barrier is designed to wrap around the ends of the CNE rather than extending parallel to the roadway four times the distance between the noise wall and the last receptor (the "4D rule"), as discussed in Section 4.2.4. Bending the noise barrier back toward the receptor creates a greater degree of visual separation while reducing the overall noise barrier length. If this approach creates a feasible and reasonable noise barrier measure (as discussed in Section 4.2.1), additional land acquisition or property owner agreements with adjacent landowners may be considered. Agreements or environmental commitments to execute this should be obtained prior to final design.

### Noise Barrier Zone of Effectiveness

Noise barriers can be most effective in reducing noise for areas within 200 feet of the highway, which is the shadow zone of the noise barrier. Areas beyond this have been known to receive some traffic noise reduction; however, this may not be a substantial noise reduction and may not be a perceptible change from the condition without the noise barrier. The barrier's effectiveness also is highly dependent upon site and traffic conditions.

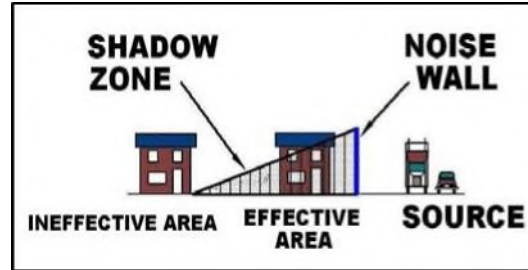

### Other Considerations

In addition to the clear zone requirements, other site constraints to noise barriers must be considered, such as utilities, line-of-sight, and drainage (as discussed in Section 4.2.7). These feasible measures should be identified as possible constraints in the early stages of project development. The final noise barrier design will be completed when final engineering is completed.

#### 4.2.4 Noise Barrier Length

TNM should be used to refine the noise barrier length and height to assure that a substantial noise reduction will be achieved. Noise barriers must be long enough and high enough to sufficiently block the view of the traffic noise sources. Barriers that are not long enough or high enough will allow too much noise to travel around the end or over the top of the noise barrier to provide a substantial noise reduction.

**FIGURE 4-4  
4D RULE**

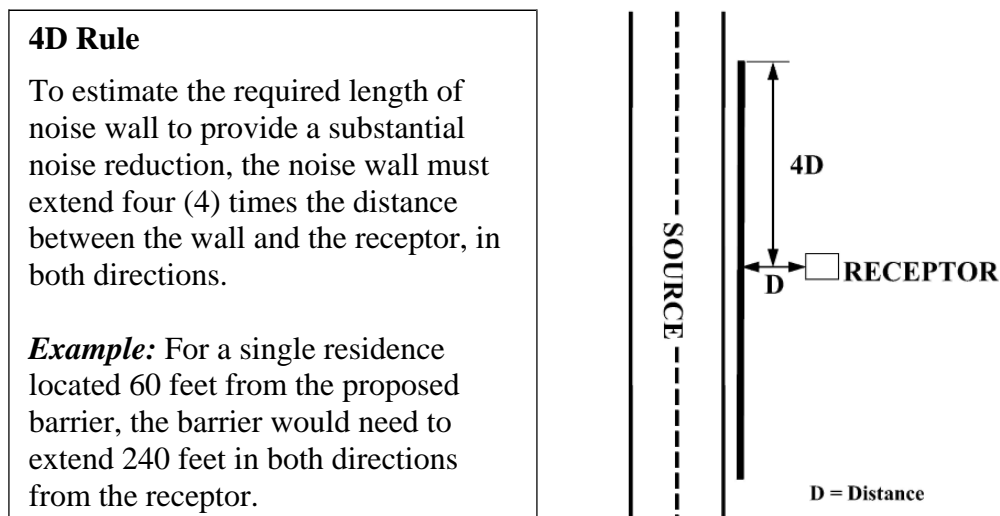

**Barrier Termini**

Traffic noise abatement must be considered for impacted areas within the project limits. If a logical terminus of the noise barrier can be determined for contiguous sensitive land uses that originate within the project limits, the noise barrier can be extended beyond the project limits if necessary to maintain continuity. For example, if the project limits terminate in the middle of an apartment complex, the other half of the apartment complex outside the project limits can be evaluated for traffic noise abatement. The noise barrier must achieve the feasibility and reasonableness criteria for it to be recommended for implementation (see Section 4.2.1). If extending the barrier length beyond the project limits results in not meeting the feasibility and reasonableness criteria, the noise barrier implementation shall be evaluated on a case-by-case basis.

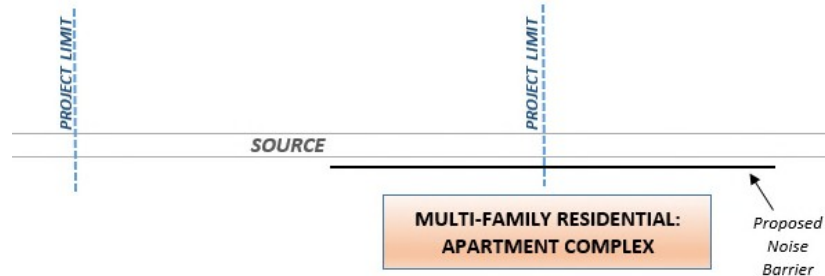

If several CNEs are adjacent and only one of the CNEs is impacted, it can be appropriate to extend barrier termini to shield CNEs not impacted, if the resulting barrier is feasible and reasonable. A receptor does not need to be impacted in order to receive a benefit from a barrier, and an extended barrier may provide benefits to receptors not impacted. In the example, CNE 1, a park, is not impacted by the project, and CNE 2, a residential subdivision, would be impacted. A barrier studied for the homes in CNE 2 could likely cover a portion of the park in CNE 1 in order to provide optimal shielding to CNE 2.

Extending the barrier to provide abatement to the rest of the park could be considered if the resulting barrier is found to be feasible and reasonable.

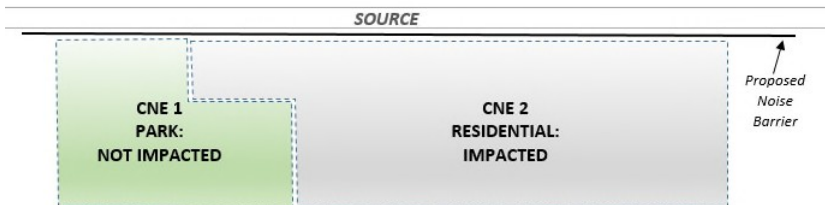

**Breaks in Noise Barriers**

Designing a continuous noise wall may not be practical for all projects. Breaks in the noise wall are required to maintain driveway openings, intersecting streets, alleys, public safety access, and pedestrian and/or bicycle accommodations and may prevent achieving the noise reduction design goal. Although breaks in a barrier reduce the barrier’s effectiveness, such a barrier must be studied for feasibility and reasonableness. Breaks in a barrier for land access, drainage, or other reasons do not necessarily make a barrier not feasible to construct.

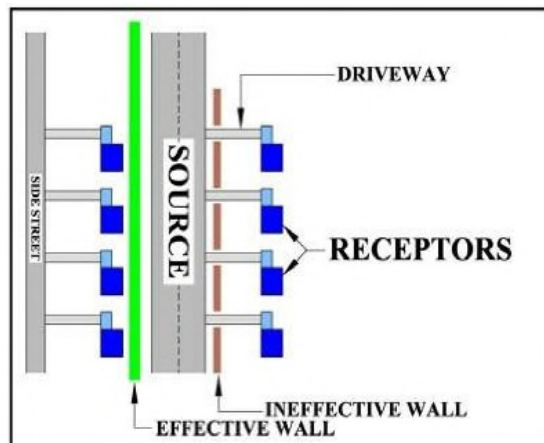

### 4.2.5 Noise Barrier Height

As discussed in the introductory paragraph to this section, a noise barrier can reduce noise levels by increasing the noise path length between the noise source and the receptor. Increasing the barrier height, therefore, causes the sound wave to take a longer path. As the sound wave path length increases, the noise levels at the receptor decrease.

#### General Noise Barrier Heights

A noise barrier needs to be at least tall enough to break the line of sight between the noise source and the receptor. Generally, the height of a truck exhaust is 8 to 12 feet. After the line of sight is broken, each additional two feet of noise barrier height will reduce the traffic noise level by approximately 1 dB(A). However, beyond a certain height, increasing the noise wall height will result in less and less improvement in the noise reductions. For example, increasing a noise wall from 12 feet to 16 feet (increase of four feet) may provide an additional 2 dB(A) reduction. However, increasing the same wall from 26 feet high to 30 feet high may only provide an additional 0.5 dB(A) reduction.

#### Maximum Barrier Height

Increasing the noise wall height should be limited to the level necessary to achieve the acoustical feasibility criteria and the noise reduction design goal as required. IDOT does not have a maximum wall height limitation. However, FHWA indicates that noise walls are typically limited to 25 feet in height for structural and aesthetic reasons (FHWA 2004). Noise walls of this height are typically not cost-effective and should be considered as having potential structural limitations or inconsistencies with local ordinances.

#### Aesthetic Considerations

FHWA guidance suggests that noise walls become visually dominating when the height exceeds one-half to one-fourth the distance between the noise wall and the receptor. For example, if the proposed noise wall location is 60 feet from the receptor, the noise wall height should not exceed 15 to 30 feet (60 feet  $\times$   $\frac{1}{4}$  to 60 feet  $\times$   $\frac{1}{2}$ ). While this is not a height restriction, it should be considered in the design process. Illustrations or renderings of proposed barriers should be provided to the public to the extent possible. FHWA suggests that additional landscaping along the community side of a noise barrier, as well as employing pleasing design and aesthetics to the community, may help to reduce a barrier's visual impact (FHWA 2004). Funding for aesthetics is assessed per individual project, and may require local (municipal or county) funding, based on FHWA and IDOT discretion.

#### Noise Barrier Height Changes

Because noise wall heights have a direct impact on the overall noise wall cost, minimizing the wall height will reduce the overall noise wall cost. Placement of the noise wall along elevated ground locations will maximize the use of natural topography and minimize noise wall heights. Depending upon the type of barrier system utilized, vertical transitions in noise barriers can be accomplished in a variety of manners, including equal height steps with consistent spacing and random height steps spaced at irregular intervals. To avoid having to cast non-rectangular panels, and for aesthetic reasons, such steps normally are designed to be located at the posts. Step changes in the wall height should not be greater than two feet unless sufficient economic, engineering, and acoustic justification is provided.

**FIGURE 4-5  
NOISE BARRIER HEIGHT CHANGES**

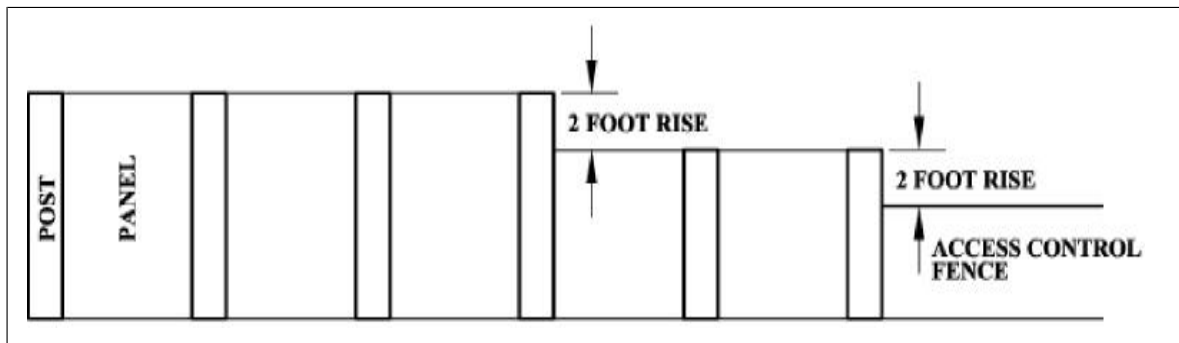

The height of a noise wall for the purpose of communicating with the designers in contract plan preparation should be referenced to the “top of wall elevation” rather than relative to the “proposed grade line” of the improvement (PGL). Reporting noise wall height as an absolute top of wall elevation minimizes translation errors that could occur between Phase I and Phase II Design changes. Other heights, such as height above the ground at the right-of-way, etc. also may be appropriate for use in the public involvement and Context Sensitive Solutions (CSS) processes. The noise barrier shall tie into adjacent features (i.e., access control fences) whenever feasible. Any additional barrier length to achieve this should be included in the reasonableness evaluation.

#### 4.2.6 Parallel Noise Walls

Multiple sound wave reflections between parallel noise walls can theoretically reduce the noise wall performance, thereby inhibiting the ability to attain the acoustical feasibility criteria or the noise reduction design goal. Reflections from earth berms are generally not a concern due to the non-reflective nature of the landscaped or grass-covered earth berms. Construction of noise walls on both sides of the roadway should be designed with width-to-height ratios of at least 10:1, with a 20:1 ratio being preferred. The width is the distance between the two noise walls and the height is the average wall height above the roadway. For example, two barriers each 10 feet tall should be placed at least 100 feet apart, preferably 200 feet apart.

The reduction in performance due to multiple noise reflections can be evaluated using the parallel barrier analysis feature of TNM. The analysis will predict the reduction in the insertion loss (the actual noise level reduction derived from the construction of the barrier) due to the multiple reflections. This modeling effort is strongly recommended for parallel barrier conditions of less than 10:1 (width: height) and should be considered for conditions between 10:1 and 20:1. Alternatives to mitigating any noise wall performance reductions include the following:





- Using absorptive noise wall materials
- Increasing the noise wall height to overcome the insertion loss degradation
- Altering the noise wall configuration to increase the width-to-height ratio.

For purposes of the traffic noise analysis documentation, parallel barrier conditions shall be identified and the width-to-height ratios provided. The results of any parallel barrier analysis shall be included in the appropriate Technical Memorandum/Report, NEPA document, or Project Report. For parallel barrier situations, the noise wall configuration shall be provided for both a reflective (non-absorptive) noise wall material and an absorptive noise wall material, as there may be height differentials between barrier types that should be identified. The traffic noise report shall document results of a parallel wall analysis for any barriers that have a width-to-height ratio less than 10:1.

**Absorptive Wall Materials** have a Noise Reduction Coefficient (NRC) of at least 0.80 on the roadway side of a wall to at least 0.65 on the community side of a wall.

#### 4.2.7 Design Consideration

##### Safety

There are two noise barrier design elements that must be considered for safety, including maintaining the clear zone (see IDOT BDE Manual Chapter 38-3, Roadside Clear Zones) and maintaining the line of sight (see IDOT BDE Manual Chapter 28, Sight Distance). A noise barrier needs to be located outside of the clear zone so that errant vehicles have sufficient opportunity to recover, thus reducing the potential for collision with the noise wall. Along interstate highways, the width of the clear zone is typically 60 feet from the edge of pavement. When desirable clear zones cannot be maintained, or the barrier is placed along the edge of pavement due to site constraints, a safety barrier such as a guardrail or Jersey barrier must be designed as part of the noise wall.

Traffic noise walls located along the roadway may impede the removal of snow and ice. This should be considered during the feasibility analysis, along with the potential for the noise wall to create continuous shadowing conditions that may cause excessive icing.

The line of sight for highway design refers to the visibility of approaching vehicles in the vicinity of on-ramps, off-ramps, and intersecting streets. A noise barrier cannot block the line of sight for vehicles. Each project should be assessed to ensure the line-of-sight to approaching vehicles is not blocked by a proposed noise barrier.

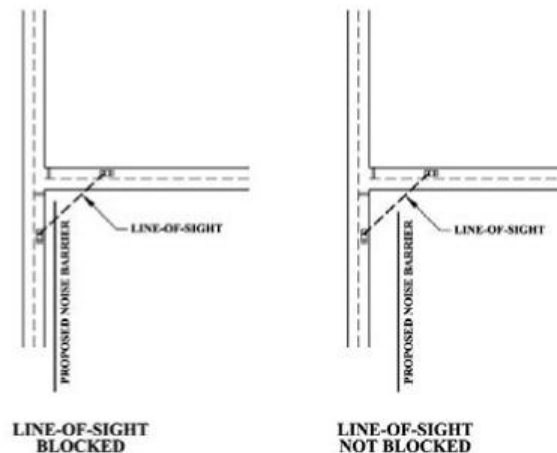

##### Maintenance

Noise barrier maintenance factors include maintenance of the noise barrier itself and of the adjacent areas. Generally, earth berms should have slopes no steeper than 3:1 to allow for

mowing. Noise walls need to be repaired in the event of damage or deterioration. Landscaping planted near the wall will similarly need maintenance. Placement of the noise wall along the right-of-way line will generally require the abutting property owners to maintain the land up to the noise wall on the receptor side of the noise wall.

Graffiti on noise walls may be a problem in some areas. Noise wall materials that can be readily repainted or readily washed should be considered in these areas. Landscaping in front of the noise wall may deter graffiti as well as enhance the visual perception of the noise wall.

Agreements with local entities may be necessary to maintain the land for areas where the property owner is other than a resident. If IDOT does not own the land on the non-roadway side of a wall, it will be necessary for IDOT to create a maintenance agreement with the local agency with jurisdiction over the non-roadway side of the wall. IDOT will replace or repair the wall if damaged, but the local agency with jurisdiction would be responsible for landscaping maintenance, as well as graffiti and trash removal.

### Drainage and Utilities

Noise barrier construction cannot conflict with drainage design elements or utilities. The design and/or location of these elements are typically determined in the final engineering design. The traffic noise documentation shall identify any known elements to be considered in the final noise wall design.

There are noise wall design elements that are compatible with drainageways, or allow drainage to pass through the wall without compromising the noise wall's effectiveness. Two examples of these drainage-compatible design elements include:

- Wall overlaps that use the 4D rule for overlaps where a break in the wall needs to occur for drainageways
- Drainage flaps can be installed in the base of the wall to allow some water to pass through the wall without creating a full break in the wall.

### 4.3 Right-of-Way/Pavement Treatment Considerations

Landscaping (vegetation), pavement design and sight screens are often referenced as potential alternatives to noise abatement measures. However, while these may be incorporated into project, these are not considered traffic noise abatement measures.

#### 4.3.1 Landscaping (Vegetation)

Landscaping is not recognized by the FHWA as a traffic noise abatement measure; however, landscaping can provide traffic noise reductions if it is sufficiently wide, dense and tall such that it cannot be seen through or over. Generally, the vegetation needs to be between 100 and 200 feet in width, 16 to 18 feet tall, and with dense understory growth to obtain a perceivable noise reduction of 5 dB(A). It is generally not feasible to plant this number of trees or have available sufficient right-of-way for this to be a

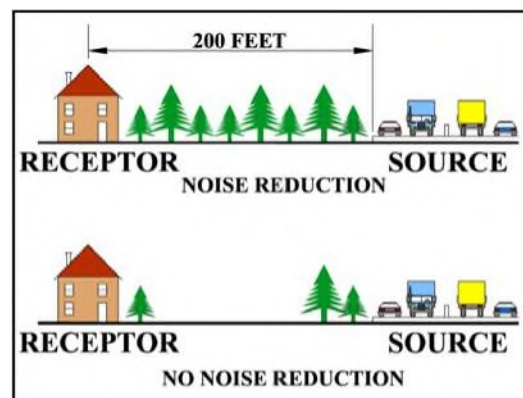

prudent abatement measure.

Landscaping along the right-of-way that at least creates a visual barrier can provide aesthetic benefits and psychological relief even if noise levels are not reduced. Implementation of landscaping as an alternative to noise abatement for an impacted receptor can be considered as an offsetting mitigation on a case-by-case basis. However, it must be documented that the public has accepted this as an alternative and understands that it is being provided for visual, privacy, or aesthetic purposes only and will not be effective in abating traffic noise impacts.

#### **4.3.2 Pavement Design**

Quiet pavements have been identified by some states as a way to reduce traffic noise up to 3 to 4 dB(A). FHWA only recognizes this measure as eligible for Federal funding if the state has an approved Quiet Pavement Research Program. IDOT does not currently have an approved Quiet Pavement program.

As pavement texture varies with time, the performance of this measure is difficult to predict for noise abatement. For example, asphalt pavement breaks apart, while concrete textures wear down over time. Winter conditions and snowplows exacerbate pavement wear. In addition, noise created at the tire and pavement interface is only one of several traffic noise sources that include engine, exhaust and auto body vibrations. In summary, altering the pavement material does not result in substantial noise reductions over a long-term period.

#### **4.3.3 Sight Screens**

Sight screens are typically implemented into a project design for the purpose of creating a visual barrier between the sensitive land use area and the roadway. Similar to landscaping, a sight screen provides psychological relief. Barrier materials need to have substantial density (approximately 4 pounds per square foot or greater) and no openings to provide a perceivable traffic noise reduction if it is long enough and tall enough. Typically, most sight screens do not meet these criteria and consequently do not reduce traffic noise levels.

# 5. CONSTRUCTION NOISE

## 5.1 Applicability

Construction noise must be considered as part of the development of any transportation facility. Roadway construction is often conducted in proximity to residences and businesses and should be controlled to avoid excessive construction noise impacts. The latest version of the IDOT *Standard Specifications for Road and Bridge Construction*, Article 107.35 (IDOT 2012), specifies construction noise restrictions.

## 5.2 Construction Noise Evaluation

Construction noise varies greatly depending on the equipment being used, the condition of the equipment, and the activities being conducted. Noise levels also depend on the time and duration of the construction activity. Noise from construction equipment is primarily from the engine and exhaust that may consist of both stationary and mobile sources. Mobile construction equipment rarely travels at high speeds where wind noise and tire noise are critical.

The need for a construction noise analysis and potential construction noise monitoring shall be evaluated on a case-by-case basis. Longer duration projects, projects with loud equipment and projects with loud operations with sensitive receptor locations nearby should be considered for a construction noise analysis.

The FHWA has developed the FHWA Roadway Construction Noise Model (FHWA RCNM) Version 1.0 (FHWA 2006). This model is not required on Federal-aid projects; however, it is a screening tool that can be used during project development for the prediction of construction noise. The FHWA RCNM incorporates an extensive construction equipment noise database and these parameters can be modified according to each user's needs.

## 5.3 Construction Noise Abatement

Abatement of construction noise can be accomplished by construction staging, sequencing of operations, or alternative construction methods. Typically, the construction methods to be used for a project are determined in the final engineering design. The NEPA document should therefore identify the potential for construction noise impacts and reference the following abatement measures, as appropriate.

### Construction Staging

- Construct noise barriers that were identified as feasible and reasonable, during the initial construction phases to reduce construction noise. Noise barriers include installing permanent or temporary noise walls, temporary stock piles, or equipment enclosures for noisy equipment, such as shields or heavy curtains.
- Route construction traffic away from sensitive receptors.
- Operate equipment as far from sensitive receptors as feasible.

### **Sequence of Operations**

- Conduct louder operations during the day and not during the night, when people are much more sensitive to noise.
- Conduct multiple loud construction operations at one time. The total noise level from multiple activities will not substantially increase the noise level. However, it will reduce the total duration of that noise level.

### **Alternative Construction Methods**

- Evaluate alternative pile driving methods, as this is a major noise contributor.
- Evaluate quieter demolition methods.
- Use special muffler systems or enclose equipment, i.e., curtains.

### **5.4 Construction Noise Documentation**

The following construction noise statement should be included in the NEPA document or Project Report:

“Trucks and machinery used for construction produce noise which may affect some land uses and activities during the construction period. Residents along the alignment will at some time experience perceptible construction noise from implementation of the project. To minimize or eliminate the effect of construction noise on these receptors, mitigation measures have been incorporated into the Illinois Department of Transportation’s Standard Specifications for Road and Bridge Construction as Article 107.35.”

During project development, if construction noise issues are raised by the public, the districts should discuss the need for a quantitative construction noise assessment with the IDOT Noise Specialist. If the project warrants a quantitative construction noise assessment, the documentation shall include the following:

- Identification of potential receptors that may be affected by construction noise.
- Determination of potential construction noise levels using the FHWA RCNM.
- Determination of abatement measures to be included in the contract plans and specifications.

### **5.5 Vibration Impacts During Construction**

Highway traffic traveling on a roadway has the potential to be a source of vibration. Vibration associated with roadway traffic is typically caused by heavy trucks traveling over discontinuities in the pavement, such as potholes or expansion joints; however, traffic, including heavy trucks, rarely generates vibration levels that cause damage to structures. Many highway improvement projects will typically address these discontinuities, thereby reducing the potential for vibration issues.

Similar to construction noise, construction vibration is dependent on the equipment being used, the condition of the equipment and the activities being conducted. Construction vibration impacts generally do not approach levels that can damage nearby structures. The exception that should be considered is the potential for historic structure impacts.

FHWA has not developed vibration impact assessment methodologies. However, the USDOT Federal Transit Administration (FTA) has developed vibration assessment guidelines as part of the Transit Noise and Vibration Impact Assessment methodology (FTA 2006). Construction vibration should be assessed when there is potential for vibration impacts from construction activities, as determined on a case-by-case basis. Construction activities typically associated with vibration include pile driving, blasting, pavement breaking, or earth moving in close proximity to sensitive receptors.

### **5.5.1 Vibration Monitoring**

Vibration is commonly described using the oscillatory motion of particles, including displacement, velocity and acceleration; however, most equipment used to measure vibration directly measures velocity or acceleration of particles and not displacement. Vibratory motion is typically reported as a peak particle velocity (PPV) or peak particle acceleration (PPA). PPV is often used as the descriptor for evaluating vibration impacts. Vibration monitoring is typically performed using two types of equipment, a seismometer (measures velocity) or an accelerometer (measures acceleration). Seismometers are typically larger in size than accelerometers and can be placed directly on the ground. They also are more sensitive to low levels of vibration. Accelerometers are smaller than seismometers but have a larger frequency range. Accelerometers are usually not placed directly on the ground and must be mounted in some way.

### **5.5.2 Vibration Abatement**

Potential abatement measures that could be considered include the following:

#### **Construction Staging**

- Route construction traffic away from sensitive receptors.
- Operate equipment as far from sensitive receptors as feasible.

#### **Sequence of Operations**

- Conduct vibration operations during the day and not during the night, when people are much more sensitive to vibration.
- Conduct vibration operations one at a time - vibration levels may be much less if generated independently.

#### **Alternative Construction Methods**

- Evaluate alternative pile driving methods, as this is a major vibration generator - the pile driving technique will likely depend on geological conditions.
- Evaluate demolition methods that reduce impact.
- Do not use vibratory equipment for soil stabilization or packing near sensitive receptors.

## 6. TRAFFIC NOISE REPORTING

This section presents the necessary documentation required when summarizing the noise analysis results in NEPA documents. Additionally, this section presents the information that needs to be shared with the public and local officials.

### 6.1 Traffic Noise Report

The Traffic Noise Report should include information regarding the receptor selection, noise monitoring (if applicable), noise modeling methodology, noise modeling results, impact analysis, and abatement analysis. The TNM files for the scenarios reported in the environmental document and/or the Traffic Noise Report can be provided in electronic format with the documentation. Barrier design information for the purpose of communicating with the designers in contract plan preparation should be included, referencing the “top of wall elevation” rather than the height above the proposed grade line (PGL) of the improvement. **Reporting noise wall height as an absolute top of wall elevation minimizes translation errors that could occur between Phase I and Phase II Design changes.** Other heights, such as height above the ground at the right-of-way, etc. also may be appropriate for use in the public involvement and CSS processes.

An example Traffic Noise Report outline is provided in Appendix A.

Include a statement of likelihood in both the technical memorandum/report and the NEPA document or project report when noise walls are deemed feasible and reasonable, as cited in Section 6.2. The statement of likelihood used will depend on the timing of viewpoints solicitation for the project.

### 6.2 NEPA Documents

For language to include in the NEPA document, see Section 26-6 of the BDE Manual and Appendix D Guidance on EA/EIS Preparation, if applicable.

### 6.3 Coordination with the Public

The level of public involvement will vary from one project to another and is influenced by the type of project (See Chapter 19), level of noise impacts that may result as well as proposed abatement measures, and general interest shown by the public.

If a project is likely to result in noise impacts, an extra effort should be made to involve the public and more specifically, benefited receptors at the earliest stage reasonable. The timing of this involvement will vary from project to project; however, it should generally occur when traffic noise impacts and proposed abatement measures have been identified.

As part of the public involvement process, the results of the traffic noise analysis should be presented at the public meeting/hearing for any proposed noise barriers or other noise abatement measures. The information is typically presented on project exhibits and should include evaluated noise barrier locations, noise barriers likely to be implemented as part of the project design or locations of other proposed noise abatement measures. Supporting traffic noise analysis information (i.e., traffic noise memorandum/report) should be available for review at the public meeting or hearing. The noise abatement measures should be depicted on exhibits and may fall under one of the following descriptions:

- Public Hearing Coordination for Phase I Viewpoints Solicitation: Show all barriers that were voted in favor during Phase I Viewpoints Solicitation, with the following description:
  - Noise Abatement Measure Likely to be Implemented
- Public Hearing Coordination for Phase II Viewpoints Solicitation: Show all barriers to be voted upon in Phase II (barriers that are feasible, meet the NRDG, and are cost effective), with the following description:
  - Noise Abatement Measure Likely to be Implemented Pending Phase II Viewpoints of Benefited Receptors

Additional noise abatement measures that are not feasible or reasonable may be depicted on exhibits using one of the four following descriptions:

- Noise Abatement Measure not Feasible
- Noise Abatement Measure not Reasonable (does not achieve noise reduction design goal)
- Noise Abatement Measure not Reasonable (does not achieve cost effectiveness criteria)
- Noise Abatement Measure not Reasonable (majority of benefited receptors do not desire the abatement measure)

The purpose of sharing the traffic noise analysis information is to solicit comments from local officials, property owners and residents adjacent to the project area, with particular emphasis given to benefited receptors. The public meeting or hearing is one of the recommended mechanisms to obtain viewpoints from benefited receptors. Every effort should be made to identify the intent and need of getting documented feedback from the benefited receptors. This may include identifying benefited receptors on the exhibits.

Section 4.2.1.2 includes a section on “Viewpoints of Benefited Receptors” as part of the reasonableness evaluation and an example evaluation is provided in Appendix C. Section 4.2.1.2 presents the methodology to solicit the information and a template letter that could be used to request viewpoints on the proposed noise abatement measure. Additionally, the section presents a methodology to determine the majority viewpoint for each abatement measure with a potential to be implemented. The solicitation of viewpoints is not required for a noise abatement measure that does not achieve the feasibility criteria or the reasonableness criteria based on the noise reduction design goal or cost-effectiveness.

The views of benefited receptors are a major consideration in determining the reasonableness of that proposed abatement measure. Comments from the benefited receptors regarding noise wall texture and color also will be considered; however, all design features are ultimately decided upon by IDOT.

In order for any proposed noise wall comment from benefited receptors to be taken into consideration, it must be submitted in writing in letter format, e-mail or recorded at a public meeting or public hearing.

#### **6.4 Coordination with Local Officials**

The purpose of coordinating with local officials is to provide information and promote compatible land development and land use planning adjacent to proposed highway projects. Compatible land use planning is an important tool for preventing future noise impacts. The traffic noise study results should be presented to the local officials having jurisdiction within



the study area and they should be involved in the planning process as early as possible. In addition to the information presented in the Technical Noise Memorandum/Report, local officials shall be provided with the following:

- Estimated future noise levels (for various distances from the proposed highway improvement) for undeveloped lands or properties in the immediate vicinity of the project that are not permitted or for agricultural lands. Specifically, distances from the edge of pavement to the traffic noise impact limits should be provided for the undeveloped lands. This may be accomplished using noise contours. It is recommended that this information be sent directly to the local officials.
- Information that may be useful to local communities to protect future land development from becoming incompatible with anticipated highway traffic noise levels.

The FHWA has developed a document entitled *Entering the Quiet Zone: Noise Compatible Land Use Planning* that could be recommended to the local officials to inform them of noise compatible planning concepts (Texas Southern University/FHWA, 2002).



## REFERENCES

1. American Association of State Highway Transportation Officials. "A Policy on Geometric Design of Highways and Streets." Washington, D.C. 2001
2. Bajdek, Christopher, Christopher Menge, Ruth Anne Mazur, Alan Pete, and Jeremy Schroeder. "Recommended Best Practices for the Use of the FHWA Traffic Noise Model (TNM) TNM Object Input, Noise Barrier Optimization, and Quality Assurance. US Department of Transportation, Federal Highway Administration. December 8, 2015, p. 29.
3. Harris Miller Miller & Hanson, Inc.(HMMH), Bowlby & Associates, Inc., Environmental Acoustics, Grant S. Anderson, and Douglas E. Barrett. Supplemental Guidance on the Application of FHWA's Traffic Noise Model. National Academy of Sciences, National Cooperative Highway Research Program. NCHRP Report 791. Project 25-34. 2014.
4. Illinois Department of Transportation. Bureau of Design and Environment Manual. Chapter 26-6.05(c). December 2016.
5. Illinois Department of Transportation. Standard Specifications for Road and Bridge Construction. Article 107.35, Construction Noise Restrictions. April 1, 2016.
6. U.S. National Archives and Records Administration. 2010. Code of Federal Regulations. Title 23. Procedures for Abatement of Highway Traffic Noise and Construction Noise.
7. USDOT, FHWA, Measurement of Highway Related Noise. Office of Environment and Planning, Washington, D.C., May 1996. [FHWA-PD-96-046, DOT-VNTSC-FHWA-96-5.
8. USDOT, FHWA, FHWA Traffic Noise Model (FHWA TNM) Version 1.0 – Technical Manual. Research and Special Programs Administration. FHWA-PD-96-010. Final Report February 1998.
9. USDOT, FHWA, Entering the Quiet Zone: Noise Compatible Land Use Planning. [Brochure prepared by Texas Southern University, 2002.
10. USDOT, FHWA, FHWA Highway Noise Barrier Design Handbook. 2004.
11. USDOT, FHWA, Roadway Construction Noise Model User's Guide, FHWA-HEP-05-054, January 2006.
12. USDOT, FHWA, The Little Book of Quieter Pavements. FHWA-IF-08-004. July 2007.
13. USDOT, FHWA, Ground and Pavement Effects using FHWA's Traffic Noise Model 2.5. Research and Innovative Technology Administration. April 2010
14. USDOT, FHWA, Highway Traffic Noise: Analysis and Abatement Guidance. FHWA-HEP-10-025 December 2011

15. USDOT, FHWA, Noise Policy FAQs – Frequently Asked Questions. October 2015.  
[http://www.fhwa.dot.gov/environment/noise/regulations\\_and\\_guidance/faq\\_nois.cfm](http://www.fhwa.dot.gov/environment/noise/regulations_and_guidance/faq_nois.cfm)
16. USDOT, Federal Transit Administration (FTA), Transit Noise and Vibration Impact Assessment (FTA-VA-90-1003-06), May 2006.

## GLOSSARY

**23 CFR 772.** (Title 23, Code of Federal Regulations, Part 772) “Procedures for Abatement of Highway Traffic Noise and Construction Noise”: FHWA regulations for highway traffic noise analysis and abatement during the planning and design of federally aided highway projects.

**Abatement.** Any positive action taken to reduce the impact of highway traffic noise.

**Absolute Noise Levels.** The predicted design-year noise level at the receptor without noise abatement.

**Absorptive Noise Wall.** Noise walls that tend to absorb noise.

**Attenuation.** The reduction of an acoustic signal.

**Auxiliary Lane.** The American Association of State Highway Transportation Officials (AASHTO) defines an auxiliary lane as the portion of the roadway adjoining the traveled way for speed change, turning, weaving, truck climbing, maneuvering of entering and leaving traffic, and other purposes supplementary to through-traffic movement (AASHTO, 2001).

The Department will take a broad approach to defining auxiliary lanes with respect to defining a Type I project for noise analysis. FHWA states that auxiliary lanes 2,500’ or longer should be considered a Type 1 project. For auxiliary lanes shorter than 2,500’ in length, consideration for auxiliary lanes should be limited to those that could be used as a through lane (including bus or truck lanes) rather than lanes used for parking, speed change, turning or storage for weaving. For interstates, auxiliary lanes considered to be Type 1 projects are those that are:

3. more than 2,500’ long, and;
4. are between two closely spaced interchanges or carried through one or more interchanges.

The final determination regarding Type 1 project classification will be left to the IDOT District and the Bureau of Design and Environment, on a case-by-case basis.

**Average Daily Traffic (ADT).** The total traffic volume during a given period divided by the number of days in that period. Current ADT volumes can be determined by continuous traffic counts or periodic counts.

**A-Weighted Levels.** Adjustment or weighting of sound frequencies to approximate the way that the average person hears sounds. This weighting system assigns a weight that is related to how sensitive the human ear is to each sound frequency. Frequencies that are less sensitive to the human ear are weighted less than those for which the ear is more sensitive. A-weighted sound levels are expressed in decibel units “dB(A)”.

**Barrier.** A solid wall or earth berm located between the roadway and receptor location which provides noise reduction.

**Benefited Receptor.** The recipient of an abatement measure that receives a noise reduction of 5 dB(A) or greater. A benefited receptor does not need to be an impacted receptor.

**Build Condition.** Projected traffic volumes using the proposed roadway configuration.

**Clear Zone.** Area adjacent to a roadway that is void of roadside hazards, and varies according to roadway and roadside conditions and design speeds.

**Common Noise Environment (CNE).** A group of receptors within the same Activity Category that are exposed to similar noise sources and levels; traffic volumes, traffic mix, and speed; and topographic features. Generally, CNEs occur between two secondary noise sources, such as interchanges, intersections, or cross-roads.

**Context Sensitive Solutions (CSS).** An approach that seeks involvement of the public early and throughout project development to consider a public input and a project's surroundings, or context, in decision making.

**Date of Public Knowledge.** The date of environmental approval of the Categorical Exclusion (CE), the Finding of No Significant Impact (FONSI) for an Environmental Assessment (EA), or the Record of Decision (ROD) for an Environmental Impact Statement (EIS), as defined in 23 CFR Part 771.

**Decibels (dB).** Units for measuring sound. Decibels are logarithmic units.

**Design Hourly Volume (DHV).** The 30<sup>th</sup> highest hourly volume in a year.

**Design Year.** The future year used to estimate the probable traffic volume for which a highway is designed. For NEPA, IDOT uses the latest approved traffic projections from the appropriate Metropolitan Planning Organization (MPO). For locations outside the planning area of an MPO, the design year traffic volumes shall be consistent with the traffic projections used for design.

**dB(A).** Decibels measured using the A-weighted scale.

**Engine Braking.** The act of using the energy-requiring compression of an internal combustion engine to slow down a vehicle which typically results in noise pollution.

**Existing Noise Levels.** The worst hourly noise level resulting from the combination of natural and mechanical sources and human activity usually present in a particular area at the time the noise analysis is performed.

**Facility or Existing Highway.** Any of the freeways, expressways, or various classes of roads and streets that make up the highway system under the jurisdiction of IDOT.

**Feasibility.** The combination of acoustical and engineering factors considered in the evaluation of a noise abatement measure. The acoustical criterion for feasibility requires a minimum 5 dB(A) traffic noise reduction at a minimum of two impacted receptor locations.

**FHWA.** Federal Highway Administration.

**Front Row Receptor.** Receptor whose property is adjacent to the proposed noise barrier (see Figure 4-3).

**Frequencies.** The number of cycles of a periodic motion in a unit of time. Noise frequencies are measured in Hertz (Hz).

**ETA.** Federal Transit Authority.

**Fully Controlled-Access State Highway.** A highway under IDOT jurisdiction with no at-grade intersections and no driveway access points.

**Hard Site.** Hard ground conditions, such as asphalt or concrete, that tend to reflect noise.

**Heavy Trucks.** All vehicles having three or more axles and designed for the transportation of cargo.

**Hertz (Hz).** The unit of frequency for sound; one Hertz has a periodic interval of one second.

**Impact.** See: Traffic Noise Impact.

**Impacted Receptor.** The recipient that has a traffic noise impact.

**Insertion Loss.** The actual noise level reduction derived from the construction of a noise barrier.

**L<sub>dn</sub> (Day/Night average sound level).** Average sound exposure over a 24-hour period is often presented as a day-night average sound level (L<sub>dn</sub>). L<sub>dn</sub> values are calculated from hourly L<sub>eq</sub> values, with the L<sub>eq</sub> values for the nighttime period (10:00 p.m. to 7:00 a.m.) increased by 10 dB to reflect the greater disturbance potential from nighttime noises.

**L<sub>eq</sub>.** The equivalent steady-state sound level, which in a stated period of time, contains the same acoustic energy as the time-varying sound level during the same time period, with L<sub>eq</sub>(h) being the hourly value of L<sub>eq</sub>.

**Level of Service (LOS).** A quantitative stratification of a performance measure that represents quality of traffic flow, measured on an A to F scale, with LOS A representing the best operating traffic conditions from the traveler's perspective and LOS F the worst

**Line of Sight (Barrier)** An obstruction, generally a solid wall or an earth berm, located between a noise source and a receiver.

**Line of Sight (Traffic).** The line of vision between a receptor and a noise source.

**Line Source.** Many single noise sources close together (i.e., multiple vehicles on a roadway).

**L<sub>max</sub>.** The maximum sound level measured over a time period.

**L<sub>min</sub>.** Lowest sound level measured in a given environment over a specified period of time.

**Logarithmic.** A logarithm is a short hand way to represent large numbers. A logarithmic scale increases consecutive numbers by a factor of 10. For example; log 1,000 = 3; log 10,000 = 4; log 100,000 = 5, etc.

**Medium trucks.** All vehicles having two axles and six wheels designed for the transportation of cargo.

**Multifamily Dwelling.** A residential structure containing more than one residence. Each residence in a multifamily dwelling shall be counted as one receptor when determining impacted and benefited receptors.

**National Environmental Policy Act (NEPA).** NEPA requires Federal agencies to integrate environmental values into their decision making processes by considering the environmental impacts of their proposed actions and reasonable alternatives to those actions. IDOT's Phase I project development includes NEPA and preliminary design. The completion of NEPA requires an approved Categorical Exclusion, a Finding of No Significant Impact (for an Environmental Assessment), or a Record of Decision (for an Environmental Impact Statement).

**No-Action Condition.** Modeling future (design year) traffic volumes using the existing roadway configuration.

**Noise Abatement.** Measures taken to mitigate or reduce traffic noise impacts (i.e., construction of berms or noise walls, shifting roadway alignment, etc.).

**Noise Abatement Criteria (NAC).** Noise impact thresholds for considering noise abatement for various land uses. Defined in 23 CFR Part 772.

**Noise Barrier.** A physical obstruction (i.e., stand alone noise walls, noise berms (earth or other material), and combination berm/wall systems) that is constructed between the highway noise source and the noise sensitive receptor(s) that lowers the noise level at the receptor location.

**Noise Reduction Coefficient (NRC).** A scalar representation of the sound absorbing capability of a material. An NRC of 0 indicates perfect reflection; an NRC of 1 indicates perfect absorption.

**Noise Reduction Design Goal.** The optimum desired dB(A) noise reduction determined from calculating the difference between future build noise levels with abatement, to future build noise levels without abatement. The noise reduction goal is at least 8 dB(A) for at least one benefited receptor location.

**Octave Band.** A group of frequencies whose lower boundary is one-half of the upper boundary. In acoustics, the first eight octave bands are identified by their center frequencies of 63, 125, 250, 500, 1,000, 2,000, 4,000, and 8,000 Hertz.

**Parallel Noise Walls.** Proposed noise walls that are located across from one another on opposite sides of a highway.

**Peak Hourly Traffic.** The highest hourly traffic volume of the day.

**Peak Particle Acceleration (PPA).** Maximum instantaneous particle acceleration associated with a vibratory event.

**Peak Particle Velocity (PPV).** Maximum instantaneous particle velocity associated with a vibratory event.

**Permitted.** A definite commitment to develop land with an approved specific design of land use activities as evidenced by the issuance of a building permit.



**Point Source.** One single noise source (i.e., one vehicle).

**Property Owner.** An individual or group of individuals who hold(s) a title, deed, or other legal documentation of ownership of a property or a residence.

**Reasonableness.** The combination of social, economic, and environmental factors considered in the evaluation of a noise abatement measure.

**Receptor.** A discrete or representative location of a CNE(s), for any of the land uses listed in Table 2-1.

**Reflective Barriers.** Barriers that tend to return noise to the direction of its source.

**Residence.** A dwelling unit. Either a single family residence or each dwelling unit in a multifamily dwelling.

**Sight Screen.** A structure that blocks the sight of a highway or roadway, i.e., a solid fence, landscaping, or vegetation. A sight screen would not be considered a noise abatement measure.

**Soft Site.** Soft ground conditions, such as grass, that tends to absorb noise.

**Statement of Likelihood.** A statement provided in the NEPA document based on the feasibility and reasonableness analysis completed at the time the NEPA document is being approved.

**Stopping Sight Distance.** Sum of the brake reaction distance (the distance traveled between the time the driver sees an obstruction to when the brake is applied) and the braking distance (the distance traveled while braking the vehicle to a stop).

**Substantial Construction.** The granting of a building permit by the local governing entity with permitting authority, prior to right-of-way acquisition or construction approval for the highway.

**Substantial Noise Increase.** One of two types of highway traffic noise impacts. For an IDOT project, this is defined as an increase in noise levels of greater than 14 dB(A) in the design year over the existing noise level.

**TNM.** Traffic Noise Model. FHWA's computer program for highway traffic noise prediction and analysis.

**Traffic Noise Impacts.** Design year build condition noise levels that approach or exceed the Noise Abatement Criteria (NAC) listed in Table 2-1 for the future build condition; or design year build condition noise levels that create a substantial noise increase over existing noise levels. For purposes of the IDOT policy, approach is defined as within 1 dB(A) of the NAC. Substantial increase is considered to be at least 15 dB(A).

**Transmission Loss (TL).** The accumulated decrease in acoustical intensity as an acoustic pressure wave propagates outwards from a noise source.

### **Type I Project.**

The FHWA definition of a Type I Project includes the following:

HARD COPIES UNCONTROLLED

- The construction of a highway on new location; or,
- The physical alteration of an existing highway where there is either:
  - + *Substantial Horizontal Alteration*. A project that halves the distance between the traffic noise source and the closest receptor between the existing condition to the future build condition; or,
  - + *Substantial Vertical Alteration*. A project that removes shielding and therefore exposes the line-of-sight between the receptor and the traffic noise source. This is done by either altering the vertical alignment of the highway or by altering the topography between the highway traffic noise source and the receptor; or,
- The addition of a through-traffic lane(s). This includes the addition of a through-traffic lane that functions as a High Occupancy Vehicle (HOV) lane, High-Occupancy Toll (HOT) lane, bus lane, or truck climbing lane; or,
- The addition of an auxiliary lane<sup>7</sup>, except for when the auxiliary lane is a turn lane; or,
- The addition or relocation of interchange lanes or ramps added to a quadrant to complete an existing partial interchange; or,
- Restriping existing pavement for the purpose of adding a through-traffic lane or an auxiliary lane; or,
- The addition of a new or substantial alteration of a weigh station, rest stop, ride-share lot or toll plaza.

If any part of a project is determined to be a Type I project under this definition, then the entire project area as defined in the NEPA document is a Type I project.

**Type II Project.** A Federal or Federal-aid highway project for noise abatement on an existing highway. IDOT does not maintain a Type II program.

**Type III Project.** A Federal or Federal-aid highway project that does not meet the classifications of a Type I or Type II project. Type III projects do not require a noise analysis.

**Undeveloped Lands.** Those tracts of land or portions thereof that do not contain improvements or activities devoted to frequent human habitation or use (including low-density recreational use) and for which no such improvements or activities are permitted.

**USEPA.** United States Environmental Protection Agency.

**Worst Hourly Traffic Noise.** The noise level resulting from the highest hourly volume a facility can handle while maintaining stable flow. This traffic volume will be either the design hourly volume or the maximum volume that can be accommodated under Level of Service C (i.e., where high traffic volumes begin to restrict speed and drivers' maneuverability).

---

<sup>7</sup> See glossary definition of auxiliary lane

**APPENDIX A****TRAFFIC NOISE REPORT SUGGESTED OUTLINE**

1. INTRODUCTION
2. NOISE BACKGROUND AND REGULATIONS
  - Noise Background
  - Federal Regulations
  - IDOT Policy
3. NOISE RECEPTOR SELECTION
4. FIELD NOISE MEASUREMENTS
  - Field Noise Measurement Methodology
  - Field Noise Monitoring Results
5. NOISE ANALYSIS METHODOLOGY
  - Traffic Volumes
  - Traffic Composition
  - Receptor Distance/Elevation
  - Speed Conditions
6. TNM RESULTS
7. ABATEMENT ANALYSIS
  - Abatement Alternatives
  - Feasibility
  - Reasonableness Criterion 1: Noise Reduction Design Goal
  - Reasonableness Criterion 2: Cost Effectiveness
  - Reasonableness Criterion 3: Viewpoints Solicitation
  - Likelihood Statement
8. COORDINATION WITH LOCAL OFFICIALS FOR UNDEVELOPED LANDS
9. CONSTRUCTION NOISE
10. CONCLUSIONS

**LIST OF TABLES**

## TABLES

- 1 NOISE ABATEMENT CRITERIA - HOURLY WEIGHTED SOUND LEVEL
- 2 NOISE RECEPTOR LOCATIONS
- 3 SUMMARY OF NOISE MONITORING RESULTS
- 4 NOISE IMPACT SUMMARY - TNM MODELING RESULTS
- 5 ADJUSTED ALLOWABLE COST PER BENEFITED RECEPTOR SUMMARY
- 6 NOISE WALL COST REASONABLENESS EVALUATION
- 7 COST AVERAGING ANALYSIS SUMMARY
- 8 VIEWPOINTS SOLICITATION SUMMARY

**LIST OF FIGURES**

## FIGURES

- 1 PROJECT LOCATION MAP
- 2 LAND USE MAP
- 3 NOISE RECEPTOR LOCATION MAP
- 4 ANALYZED NOISE BARRIER LOCATION MAP
- 5 NOISE BARRIERS RECOMMENDED FOR CONSTRUCTION

**LIST OF APPENDICES**

APPENDIX A: COORDINATION WITH LOCAL OFFICIALS

APPENDIX B: VIEWPOINTS SOLICITATION

APPENDIX C: TOP OF WALL ELEVATIONS FOR FEASIBLE AND REASONABLE BARRIERS

## APPENDIX B

### FREQUENTLY ASKED QUESTIONS

#### 1. **When does a traffic noise impact occur?**

In Illinois, traffic noise impacts are defined as occurring in the following situations:

- Design year traffic noise levels are predicted to approach (within 1 dB(A)), meet, or exceed the Noise Abatement Criteria (NAC) for that Activity Category.

OR

- Design year traffic noise levels are predicted to substantially increase (greater than 14 dB(A)) over existing noise levels.

*(See Section 2.3.2)*

#### 2. **When is a traffic noise analysis required?**

A noise analysis is required for state or Federal highway construction or reconstruction projects that have been determined to meet the definition of a Type I project. These projects have the potential to increase traffic noise.

*(See Section 3.2)*

#### 3. **Is every home analyzed for noise impacts?**

Every home in close proximity to the roadway is considered in the noise analysis, either directly or indirectly by representation in an area. Noise receptors are used to represent areas that are similar in land use, proximity to roadway, and basic topography. Predicting noise levels at every home is not necessary when similar location and topography would provide like noise levels. The selected representative receptor generally represents the worst-case (i.e., it is the closest to the roadway) of all receptors included in the area and noise levels can be expected to be similar for all receptors within the group. The representative area is called a Common Noise Environment (CNE).

*(See Section 3.4)*

#### 4. **Are noise levels evaluated for floors above the ground level (i.e., 2<sup>nd</sup> or 3<sup>rd</sup> floor, etc.)?**

Noise Abatement Criteria (NAC) are generally developed for activities occurring outdoors where frequent human activity occurs. Typically, this would be a ground level activity area with the most direct exposure to the traffic noise source. However, due to topography of either the roadway or the receptor, the ground floor may be shielded from the roadway outside of the line of sight and therefore a higher floor (i.e., 2<sup>nd</sup> or 3<sup>rd</sup> level floor) may have the potential for greatest impact. A higher floor will only be evaluated if frequent outdoor human activity occurs there, such as on a balcony, or the receptor is being evaluated as Activity Category D.

*(See Section 3.4)*

#### 5. **Is the number of occupants in a dwelling taken into consideration when determining the number of receptors?**

The number of receptors is not related to the number of occupants in that dwelling. For example, one single-family home is counted as one receptor, regardless of how many people live there. Other

land uses may be dependent on the number of units within the facility such as the number of apartments in a building.

*(See Section 3.4 and 4.2.1.2)*

**6. If a receptor is located beyond 500 feet from the project area, should it be included in the noise analysis?**

Although 500 feet is used as the initial screening distance for receptors, sensitive receptors, such as nursing homes or schools, located further than 500 feet could be included on a case-by-case basis if the potential exists for them to be impacted by the project. FHWA's performance evaluation of TNM (FHWA 2010) found that highway traffic noise is not usually a serious problem at distances greater than 500 feet from heavily traveled freeways or more than 100 to 200 feet from lightly traveled roads

Factors to consider when evaluating receptors greater than 500 feet include terrain and other structures between the receptor and the roadway that may be blocking the line-of-sight. For example, if a church is located 600 feet from the roadway and there is only open field in between, it should be included in the noise analysis; however, if there are several rows of homes in between the church and the roadway, it would not have to be included.

*(See Section 3.4)*

**7. Is weather accounted for when measuring noise levels?**

Weather conditions can have some effect on noise measurement readings. Noise measurements should not be taken if the wind speed exceeds 12 mph. A wind screen on the noise monitor should be used at all times to reduce wind effects. Other site conditions necessary during the monitoring include dry pavement and no snow cover. The conditions during monitoring should always be recorded for comparison and review purposes. In the computer traffic noise model, the default weather used for analyses is 50% relative humidity and 20°C (68°F) temperature.

*(See Section 3.5.2)*

**8. Why aren't noise monitoring results used instead of modeling results when determining impacts?**

Monitored noise levels represent a snapshot of existing conditions. This means the monitored noise levels reflect weather and traffic conditions for that time period only. In addition, noise monitoring detects all noise sources present at the monitoring location, which may result in higher traffic noise levels that would not only be from the roadway.

As part of the noise analysis process, noise levels are predicted for both the existing and future conditions. The noise monitoring results are used to validate the existing conditions noise model. The traffic conditions observed during noise monitoring are entered into the existing conditions noise model. The computed noise levels from this noise model are compared with the noise levels monitored in the field. If these noise levels are within +/- 3 dB(A) the model is considered validated and is determined to provide accurate noise level predictions. This process is completed for 25 percent to 50 percent of the representative receptors in the project area.

The validated noise model is updated to account for any changes in roadway geometry and projected traffic volumes due to the proposed project to predict the future noise levels. The computer model is used to consistently predict future traffic noise levels at peak traffic which is a worst-case condition. These future noise levels, taking into account changes due to the proposed project, determine impacts.

*(See Section 3.5)*

**9. What is the source of the traffic data used in the computer model?**

There are two types of traffic data that can be used in traffic noise modeling:

- Peak Hourly Traffic; and
- Average Daily Traffic (ADT) - The total traffic volume during a given period divided by the number of days in that period. Current ADT volumes can be determined by continuous traffic counts or periodic counts.

Existing volumes are typically generated from actual traffic counts. Design year volumes are typically projected by the District or a Metropolitan Planning Organization. These design volumes are based on typical traffic growth rates, planned development and projected growth for the area.

*(See Section 3.6.1)*

**10. Can IDOT prohibit trucks along roads or reduce speed limits? Won't that reduce noise levels?**

Both of these options may reduce noise levels; however, the use of these options depends on the use of the road. If the road is a main route into and out of a city, or if there are commercial and industrial businesses along the route, a prohibition of trucks would result in adverse economic impacts. Also, by law, truck traffic cannot be prohibited on State marked routes and Interstates.

Lowering speed limits may slightly reduce traffic noise levels, but the speed reduction would lower the capacity of the roadway, thereby increasing delays, air pollutant emissions, and the overall cost of transporting goods and services. Speed limits are determined by the roadway design and speed studies.

*(See Section 4.1.2)*

**11. Would a berm be as effective as a noise wall in reducing noise levels and how does its effectiveness compare to noise walls?**

Earth berms are just as effective as noise walls. Studies have shown that earth berms actually reduce noise levels to a greater extent than noise walls. This is partially due to the soft surface of the berm (i.e., grass) providing more absorption. In addition, the flat top of the berm diffracts sound waves twice, resulting in more attenuation. However, the use of berms depends on the space available. For maintenance reasons, IDOT requires at least a 3:1 slope on berms. For example, a 12-foot high berm with a 3:1 slope would be approximately 72 feet wide at the base. The available area for abatement would need to accommodate this base width.

*(See Section 4.1.1)*

**12. Can trees/vegetation be planted to help reduce noise levels?**

Vegetation, such as a dense growth of evergreens, would need to be at least 200 feet in width and 18 feet high to reduce noise levels by 5 to 10 dB(A). In most cases, 200 feet of space between the roadway and receptors is not available without purchasing additional right-of-way. Vegetation/trees can potentially help screen the highway traffic from view.

*(See Section 4.3.1)*

**13. Why isn't noise abatement designed to reduce noise levels below the NAC?**

The Noise Abatement Criteria (NAC) identify the noise levels at which noise abatement should be evaluated. The NAC are noise levels associated with interference of speech communication and are a compromise between noise levels that are desirable and those that are achievable. They are not noise abatement goals. The objective of noise abatement is to achieve a noise reduction that will

result in a noticeable difference from the unabated traffic noise levels and can be implemented in a cost effective way. A reduction of 5 dB(A) is considered to be “readily perceptible” to the human ear. Under typical noise abatement evaluations, a substantial noise reduction is considered to be an 8 dB(A) traffic noise reduction. To be considered “feasible,” noise abatement measures must reduce noise levels by at least 5 dB(A) for at least two **impacted** receptors, and to be considered “reasonable,” noise must be reduced by at least 8 dB(A) for at least one **benefited** receptor. For example, the following table demonstrates the noise reduction goals to meet the criteria.

Location	Future Noise Level	NAC	Noise Reduction Design Goal	Target Noise Level
Site 1	69 dB(A)	67 dB(A)	8 dB(A)	61 dB(A)
Site 2	78 dB(A)	67 dB(A)	8 dB(A)	70 dB(A)

There also are limitations to the potential insertion loss, or difference in sound level, provided by a noise barrier. A properly-designed noise barrier can provide up to a 10 dB(A) insertion loss at receptors located directly behind the center of the barrier, which is a 90 percent reduction in sound energy, and results in noise perceived as half as loud as the unabated noise levels. A 20 dB(A) insertion loss is nearly impossible for a barrier to achieve due to materials reasonably available and feasible to construct. The IDOT Noise Reduction Design Goal is set at a level that will provide a noticeable benefit to the receptors behind it, while remaining an achievable goal.

Barrier Insertion Loss	Design Feasibility	Reduction in Sound Energy	Relative Reduction in Loudness
5 dB(A)	Easily Attainable	68%	Readily perceptible
10 dB(A)	Attainable	90%	Half as loud
15 dB(A)	Very difficult	97%	One-third as loud
20 dB(A)	Nearly impossible	99%	One-fourth as loud

(See Section 4.2.1.2)

**14. Why aren’t noise barriers proposed in some cases?**

A noise barrier may be proposed when a noise impact occurs and the noise barrier is determined to be feasible and reasonable. A noise barrier is determined to be feasible if it achieves at least a 5 dB(A) traffic noise reduction for at least two impacted receptors. Constraints such as driveway access and elevation of the receptor, may prevent achievement of a 5 dB(A) reduction, and therefore it may not be feasible. Other feasibility factors that influence if a noise barrier will be proposed include whether or not sufficient right-of-way is available for the safe placement of the barrier, impacts to the line-of-sight of approaching vehicles in the vicinity of on-ramps, off-ramps, and intersecting streets and/or interference with utilities and/or drainage design elements.

A noise barrier also must be reasonable, which includes three criteria.

- It must meet the noise reduction design goal of achieving at least an 8 dB(A) reduction for at least one benefited receptor.
- The estimated build cost per benefited receptor must be less than or equal to the allowable cost per benefited receptor. The base allowable cost per benefited receptor is \$30,000 per benefited receptor. The allowable cost may be adjusted based on the absolute noise level, the change in noise level and the construction date of the receptor relative to the roadway facility. For example, if a noise barrier will benefit 10 residences, and the total cost of the noise barrier is \$240,000, then the cost per benefited receptor would be \$24,000 and the noise barrier would be considered economically reasonable.



- If noise abatement measures are determined to be feasible and achieve the first two reasonableness criteria, the benefited receptor viewpoints must be considered. If the majority of the viewpoints are in favor of the noise barrier, then the noise barrier would be considered “likely to be implemented.”

If a noise barrier is not considered feasible or reasonable for an area, the noise barrier abatement measure will not be implemented as part of the project.

*(See Sections 4.2.1)*

**15. What is the cost of a noise wall?**

The average unit cost of noise wall construction used for the noise wall evaluation is \$30 per square foot. This cost is based on Illinois construction costs and walls built. In areas where there are utilities or drainage issues that may need to be addressed, additional costs may be incurred. Typical noise walls cost about \$2,000,000 per mile.

The unit cost is re-evaluated by IDOT at least every five years and is based on actual costs incurred by IDOT from the previous years.

*(See Section 4.2.1.3)*

**16. Can the base value of \$30,000 per benefited receptor be adjusted based on site specific conditions?**

IDOT allows for the adjustment of the base value allowable cost per benefited receptor based on the absolute build noise level, the change in noise level between the existing condition and the build noise level, the whether or not the receptor was present before the construction of the roadway facility proposed for improvement. Based on the adjustments, the maximum allowable cost is \$45,000 per benefited receptor.

*(See Section 4.2.1.3)*

**17. When is sound insulation viable?**

FHWA and IDOT only consider participation in sound insulation for land uses with Activity Category D, which does not include residential units. An interior noise analysis for these land uses would be conducted if it has been determined that there are no exterior human use activity areas present or that the exterior human use areas are sufficiently shielded from the traffic noise source.

Sound insulation may be considered for Activity Category D land uses if an impact has been identified on the interior and after all other noise abatement measures have been determined to be not feasible or reasonable. If it is determined that alternative noise abatement measure other than sound insulation would be feasible and reasonable based on all the criteria other than the viewpoints of the benefited receptor, IDOT will only consider sound insulation on a case-by-case basis. FHWA will consider participation on a case-by-case basis.

*(See Section 4.1.6)*

**18. How do you determine the noise impacts and feasibility of noise abatement of special types of land uses, such as schools or parks?**

IDOT uses a “Representative Receptor Unit” for determining the number of receptors potentially impacted and/or benefited by a project. The evaluation then proceeds in the same way as for a residential receptor.

### Noise Receptor Assignments

Receptor Type	FHWA Activity Category	Receptor Unit(s)
Single-family Residence	B	Each residential unit with exterior use area (i.e., patio, yard, deck, etc.)
Multi-family Residence	B	Each residential unit with access to the exterior common area (i.e., pool, benches, or building entrance) or with exterior use areas (i.e., patio or balcony)
Nursing Home	C	Each residential unit with access to an exterior common area (i.e., benches or main entrance) or with exterior use areas (i.e., patio or balcony)
School	C	Each classroom with access to an exterior use area (i.e., benches, playground, main entrance)
Hospital or In-patient Medical Facility	C	Each hospital room with a bed(s) with access to an exterior use area (i.e., benches or main entrance)
Cemetery	C	Each exterior area of anticipated gathering (i.e., benches, information board)
Auditoriums	C	Each exterior area of anticipated gathering (i.e., bench or main entrance)
Day Care Center	C	Each exterior area of anticipated gathering (i.e., playground or main entrance)
Campground	C	Each campsite within the noise study area.
Sports Fields	C	Each exterior area of anticipated gathering (i.e., dugout, bleachers, field)
Places of Worship	C	Each exterior area of anticipated gathering (i.e., benches, patio, gazebo, or main entrance)
Golf Courses	C	One receptor per hole in the worst-case noise location (tee box, fairway, green), in addition to other exterior use areas (i.e., benches, putting green)
Parks / Recreational Area	C	Each exterior use area (i.e., gazebo, picnic tables, play equipment)
Trails and Trail Heads	C	Each exterior area of anticipated gathering (i.e., bench, information board)
Libraries*	C	Each exterior area of anticipated gathering (i.e., bench, patio, gazebo)
Office*	E	Each business with an exterior use area (i.e., bench or picnic tables)
Hotel/Motel*	E	Each hotel/motel room with access to an exterior use area
Restaurants/Bars*	E	Each exterior area of anticipated gathering (i.e., group of tables)
Medical Office or Out-patient Medical Office*	E	Each exterior area of anticipated gathering (i.e., bench or tables)
Undeveloped Lands	G	Uses with an NAC and a building permit that have access to a planned exterior use area

Note: This listing is comprehensive, but not exhaustive

(See Section 3.4.1)

**19. Can alternative materials or designs to IDOT standard noise barriers be used?**

Based on testing and research results, IDOT has currently approved three types of materials for noise barriers:

- Barrier walls using concrete;
- Barrier walls using composite materials; and
- Earth berms

Other materials may be considered if they meet IDOT's criteria for noise abatement wall materials. The noise wall material must achieve a sound Transmission Loss (TL) (i.e., a reduction in sound transmitted through the material) equal to or greater than 20 dB in all one-third octave bands from 100 hertz to 5,000 hertz, inclusive. Testing for TL shall be in accordance with ASTM E90 "Standard Test Method for Laboratory Measurement of Airborne Sound Transmission Loss of Building Partitions." Specialty items and materials that are not covered by ASTM, AASHTO, or other IDOT specifications must have the prior approval of the Illinois Highway Development Council (IHDC). Contact the Engineer of Technical and Product Studies at the Bureau of Materials and Physical Research for additional information on the IHDC process. "Non-standard" noise wall designs, such as alternative patterns for a concrete wall, may be considered, but any costs exceeding that of a "standard" noise wall must be funded by the local sponsor.

*(See Section 4.2.2)*

**20. Does a noise wall absorb noise or does noise bounce off the wall?**

This depends on the type of noise wall constructed. An absorptive wall is designed to absorb noise and keep it from reflecting off the noise wall. The absorptive capacity of the wall material is specified by the NRC, which can range from 0.00 to 1.00, with 1.00 representing 100 percent absorption. To be considered absorptive by IDOT, the NRC must be at least 0.80 on the roadway side of a noise wall and at least 0.65 on the side of the wall away from the roadway.

A reflective wall is a wall not composed of an absorptive material and consequently, noise reflects off the wall back toward the source. The reflected noise level is significantly less than the noise level coming directly from the source. This is due to the additional distance the reflected noise travels, thereby dissipating the sound (reducing noise energy). Generally, the increase in noise levels due to reflections is not perceivable and therefore negligible. Unless IDOT noise walls are specified as absorptive, IDOT noise walls are typically reflective.

*(See Sections 4.2.2 and 4.2.6)*

**21. When is it appropriate for parallel barriers to be proposed?**

Parallel barriers can be proposed; however, it is strongly recommended that the reduction in performance due to multiple noise reflections be evaluated using the parallel barrier analysis sub-program of TNM. For parallel barrier situations, the noise wall configuration shall be provided for both a reflective (non-absorptive) noise wall material and an absorptive noise wall material, as there may be height differentials between barrier types that should be identified. Construction of noise walls on both sides of the roadway should be designed with width-to-height ratios of at least 10:1, with a 20:1 ratio being preferred. The width is the distance between the two noise walls and the height is the average wall height above the roadway.

*(See Section 4.2.6)*

**22. How long does the noise wall need to be?**

Generally, to be effective, the noise wall should extend 4 times the distance between the receptor and the noise wall. In other words, if the distance between the house and the noise wall was 50 feet, the noise wall would need to extend 200 feet beyond the receptor in each direction.

*(See Section 4.2.4)*

**23. Why can't a taller wall be built to get greater noise reduction?**

The barrier height is just one element that affects the traffic noise reduction achieved. A noise wall that breaks the line of sight between the traffic noise source and noise receiver reduces traffic noise up to 5 dB(A). Each additional meter of noise wall improves the traffic noise reduction by approximately 1.5 dB(A); however, beyond a certain height, incremental changes in height do not provide additional perceptible reduction in noise level (see the figure and table below). This occurs because the wall has already intercepted a high percentage of noise energy.

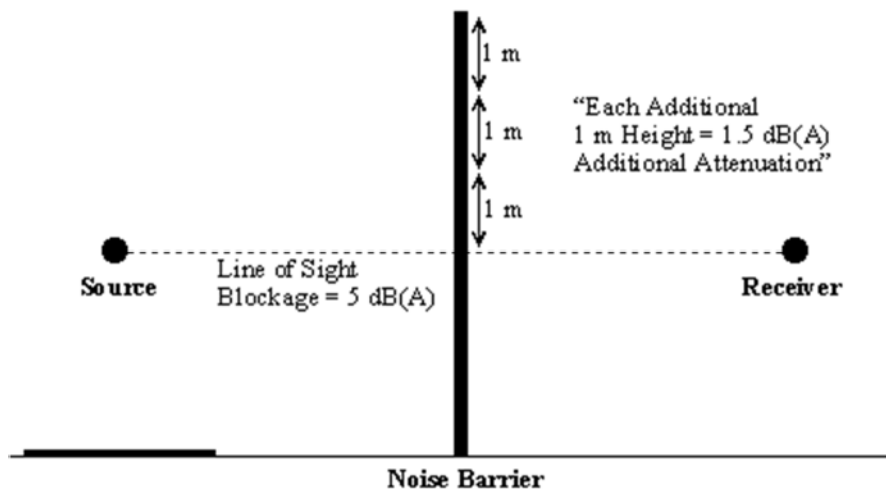

A noise barrier should not be designed at a height beyond that which is necessary to obtain the targeted level of noise reduction.

Reduction in Sound level	Degree of Attainability
5 dB(A)	Easily Attained
10 dB(A)	Attainable
15 dB(A)	Very Difficult
20 dB(A)	Nearly impossible

*(See Section 4.2.5)*

**24. When should interior noise be evaluated?**

Interior noise should only be evaluated when it has been determined that there are no exterior activities that could be potentially impacted by traffic noise. Interior noise impact analysis applies to Activity Category D. See Q/A #18

*(See Section 3.7.1)*

**25. How does IDOT address construction noise?**

- Construction noise is an inevitable result of project construction but IDOT considers ways to eliminate and/or minimize noise. IDOT may evaluate construction noise to see:
- if there is sufficient need for recommending construction of barriers prior to completion of remaining portions of project construction if provisions for any of the following measures should be used requiring special construction measures:
  - work hour limits
  - equipment muffler requirements
  - location of haul roads
  - elimination of “tail gate banging,” reducing backing for equipment with rear backing alarms
  - use of “sound curtains”
  - placing material stockpiles to form temporary noise barriers
  - position equipment as far as practical from sensitive areas
- if the duration of contract period should be limited (calendar date of completion)
- if construction during special events, such as outdoor concerts and athletic events, should be limited

*(See Section 5)*

**26. What are some of the positive and negative attributes of noise wall construction?**

- Positive Attributes
  - Easier conversation
  - Better sleeping conditions
  - Windows open more often
  - Outside more in summer
  - More privacy
- Negative Attributes
  - Restricted view
  - Feeling of confinement
  - Loss of air circulation
  - Loss of sunlight and lighting
  - Eyesore if barrier not maintained
  - Graffiti
  - Maintenance requirements

**27. Can noise contour lines generated in TNM be used to determine traffic noise impacts and/or in the noise abatement analysis?**

Using noise contour lines to determine noise impacts or for the noise abatement analysis is not recommended as they provide only an approximation of the noise levels. Typically, noise contour

lines are only used for planning purposes. This would be an acceptable method to depict the information needed to share with local officials for undeveloped lands. The contours would allow for the depiction of the areas anticipated to be impacted based on the various NAC.

*(See Section 3.7.5)*

**28. If a benefited receptor is a rental property, whose input is sought when determining the desire for noise abatement?**

As part of the reasonableness evaluation, the viewpoints of benefited receptors are required for the evaluation. In the case of rental properties, both the property owner and renter are solicited for input. Each renter in a benefited unit would provide one "viewpoint" while the property owner would provide one viewpoint for each benefited unit owned.

*(See Section 4.2.1.2)*

**29. Is a noise analysis required for a Type III Project?**

A traffic noise analysis or abatement evaluation is not required for a Type III project. Type III projects do not involve added capacity, construction of through lanes, changes in the horizontal or vertical alignment of the roadway, or exposure of noise sensitive land uses to a new or existing highway noise source.

*(See Section 3.2)*

**30. During the CSS process for the project, the stakeholders indicated that they did not want a noise wall. Does IDOT solicit the viewpoints from project stakeholders, or only from benefited receptors?**

Public input on traffic noise and traffic noise abatement received through the public involvement process including CSS, is encouraged. In prior versions of the IDOT noise policy, local jurisdictions were the primary voting body for noise barriers; however, FHWA (23 CFR Part 772) now puts that vote to the public, and only the viewpoints of the benefited receptors are considered when determining reasonableness of abatement.

*(See Section 4.2.1.2)*

**31. If a noise wall is determined to be feasible and reasonable for a land use under Activity Category D, but the benefited receptor(s) determine that they don't want the noise wall, does sound insulation need to be evaluated?**

If the noise abatement evaluation for Activity Category D determines that a noise wall would be feasible (achieves a 5 dB(A) traffic noise reduction at the impacted receptor) and reasonable (achieves an 8 dB(A) traffic noise reduction for a benefited receptor AND is cost-effective), but the viewpoint solicitation indicates a lack of desire for the noise wall, the wall is not reasonable. At that point, the availability of sound insulation as a viable option for noise abatement would need to be discussed with IDOT and FHWA.

*(See Section 4.1.6)*

**32. I have a Type I project for which the primary land uses are commercial (Land Use Category E,) along the proposed improvement. Am I required to perform a traffic noise assessment for commercial properties?**

Yes. Even though the area is primarily commercial activities, traffic noise impacts need to be evaluated based on the NAC for Land Use Category E if there are exterior use areas. If noise

impacts are identified, then a noise abatement evaluation needs to be conducted. Noise abatement found to be feasible and reasonable should then be presented to the commercial properties to determine the desire for noise abatement. This should be conducted through the viewpoint solicitation process.

*(See Section 2.3.1)*

- 33. My project consists of a bridge replacement only. During project development, due to geometric deficiencies, the road profile needed to be raised, therefore, raising the bridge profile. This profile change resulted in exposing the line-of-sight between a receptor and the traffic noise source. Is this a Type I project?**

Yes. This project would meet the definition of a Type I project since the raised profile has exposed receptors to the traffic noise. A noise analysis would be required for this project.

*(See Section 2.3.1)*

- 34. The proposed project consists of resurfacing a 2.5 mile stretch of road and adding 2 new lanes of roadway along a half-mile stretch within the full 2.5-mile project. There are no sensitive land uses along the half-mile stretch where the add-lanes are proposed, but there are residential land uses along the section proposed for resurfacing only. Do I perform a traffic noise assessment for the add lanes section only or for the entire 2.5 miles of the project?**

Though resurfacing a roadway, if taken alone, is not considered a Type I project, the project needs to be considered as a whole. If any portion of a project is Type I, the entire project corridor must be treated as a Type I project. Since the lane additions would be considered Type I, the entire project is considered a Type I project and therefore, a traffic noise assessment is required to be performed for the entire 2.5-mile project.

*(See Section 2.3.1)*

- 35. If a project is primarily Activity Category B with intermittent Activity Category D land uses (Activity Category C with no exterior use areas), would the noise analysis suffice if it just evaluated the Activity Category B areas?**

No, the noise analysis needs to evaluate all activity categories within the defined project limits.

*(See Section 2.3.1)*

**APPENDIX C**

**EXAMPLE EVALUATIONS**

**Example Project #1**

- IDOT proposed add-lane project.
- Noise analysis is necessary as this is a Type I project.
- After reviewing Figure C-1 for Land Use Categories A, B, C, D, E, and G, a noise analysis is necessary as residential areas (Category B) are within the project limits – *Noise Analysis Required*.

**Receptor Selection**

- The project limits contain two distinct common noise environments (CNE 1 and CNE 2) within 500 feet of the existing and proposed roadway alignments.
- A representative receptor is chosen for each CNE, depicted in Figure C-2.

**Noise Level Predictions**

Traffic noise levels for the existing, no-build, and build scenarios were predicted according to the methodology described in Section 3, summarized in Table C-1.

**Table C-1  
Traffic Noise Prediction Results**

Receptor / CNE	Activity Category/ NAC	Existing Noise Level, dB(A)	No-Build Noise Level, dB(A)	Build Noise Level, dB(A)	Increase from the Existing to Build Scenario, dB(A)	Impact Distinction
R1 / CNE 1	B/67	63	64	65	2	No Impact
R2 / CNE 2	B/67	65	67	70	5	Impact

**Traffic Noise Impact Identification**

- Receptor R1 is not impacted, as it does not approach, meet, or exceed the FHWA NAC for Land Use Category B.
- Receptor R2 is impacted, as it exceeds the FHWA NAC. A noise abatement analysis is required.

**Figure C-1  
Project Location Map**



**Figure C-2  
Receptor Location Map**





**Abatement Analysis**

For abatement analysis purposes, the individual receptors for CNE 2 are identified, depicted in Figure C-3.

- Abatement analysis is performed for CNE 2 by considering the identified individual receptors.
- **Feasibility criterion** checked first: Wall can be built that provides at least a 5 dB(A) traffic noise reduction for at least two impacted receptors (5 dB(A) for R23 and 7 dB(A) for R2) and possible to build—*Feasibility Criterion passed.*
- **Reasonableness criterion 1** checked next: Figure C-4 shows wall can be built that provides at least an 8 dB(A) traffic noise reduction at a benefited receptor (7 benefited receptors of 8 dB(A) or greater) – *Noise Reduction Design Goal (NRDG) passed.*
- **Reasonableness criterion 2** checked next: The receptors identified as benefited (at least a 5 dB(A) traffic noise reduction) within the CNE must not exceed the adjusted allowable noise abatement cost.

To determine the adjusted allowable noise abatement cost, the build noise level, increase in traffic noise between the existing and build scenarios, and the dates the homes were built in relation to when the roadway was built must be determined for each benefited receptor. These factors are defined in Figure C-5 and Figure C-6 and summarized in Table C-2.

**Figure C-3  
R2 CNE Individual  
Receptors**



**Figure C-4  
Noise Reduction in dB(A)**



**Table C-2**  
**CNE 2 Adjusted Allowable Cost per Benefited Receptor Calculations**

Benefited Receptor Number within CNE 2	Build Noise Level, dB(A)	Increase in Noise, Existing to Build, dB(A)	Homes Built Before Roadway, Yes/No	Traffic Noise Factor	Noise Increase Factor	Homes Built Before Roadway Factor	Total: Reasonableness Factors Cost Adjustments	Total Adjusted Allowable Cost per Receptor
3	67	4	No	\$0	\$0	\$0	\$0	\$30,000
4	67	4	No	\$0	\$0	\$0	\$0	\$30,000
5	67	4	No	\$0	\$0	\$0	\$0	\$30,000
6	67	4	No	\$0	\$0	\$0	\$0	\$30,000
7	67	4	No	\$0	\$0	\$0	\$0	\$30,000
8	67	4	No	\$0	\$0	\$0	\$0	\$30,000
9	67	4	No	\$0	\$0	\$0	\$0	\$30,000
13	70	5	No	\$1,000	\$1,000	\$0	\$2,000	\$32,000
14	70	5	No	\$1,000	\$1,000	\$0	\$2,000	\$32,000
15	70	5	No	\$1,000	\$1,000	\$0	\$2,000	\$32,000
16	70	5	No	\$1,000	\$1,000	\$0	\$2,000	\$32,000
17	70	5	No	\$1,000	\$1,000	\$0	\$2,000	\$32,000
18	70	5	No	\$1,000	\$1,000	\$0	\$2,000	\$32,000
19	70	5	No	\$1,000	\$1,000	\$0	\$2,000	\$32,000
20	70	5	No	\$1,000	\$1,000	\$0	\$2,000	\$32,000
21	70	5	No	\$1,000	\$1,000	\$0	\$2,000	\$32,000
22	70	5	No	\$1,000	\$1,000	\$0	\$2,000	\$32,000
23	69	4	No	\$0	\$0	\$0	\$0	\$30,000
24	69	4	No	\$0	\$0	\$0	\$0	\$30,000
25	70	5	No	\$1,000	\$1,000	\$0	\$2,000	\$32,000
26	70	5	No	\$1,000	\$1,000	\$0	\$2,000	\$32,000
Average	---	---	---	\$571	\$571	\$0	\$1,142	\$31,142

The cost per benefited receptor for the feasible noise wall is compared to the average allowable cost per benefited receptor to determine cost effectiveness. The cost of the noise wall is calculated at \$30 per square foot of noise wall, detailed in Table C-3.

**Table C-3**  
**CNE 2 Traffic Noise Abatement Results**

Wall Length, feet	Wall Height, feet	Total Wall Square Footage	Total Noise Wall Cost	Total Benefited Receptors	Noise Wall Cost Per Benefited Receptor	Allowable Cost Per Benefited Receptor
1,500	12	18,000	\$540,000	21	\$25,714	\$31,142

- Since the noise wall cost per benefited receptor is less than allowable cost per benefited receptor, the noise wall is reasonable to construct – *The wall is cost effective.*
- Since the noise wall is feasible, meets the NRDG, and is cost effective, the final reasonableness factor requires the viewpoints of the benefited receptors to be obtained.

**Figure C-5**  
**Build Noise Level in dB(A)**



**Figure C-6**  
**Noise Level Increase in dB(A)**



- **Reasonableness criterion 3** checked last: The feasible and reasonable noise wall being considered for CNE 2 was presented to the benefited receptors to solicit their viewpoints. The results of the survey are detailed in Table C-4.

**Table C-4  
CNE 2 Benefited Receptor Survey Results**

R2 Benefited Receptor Number within CNE 2	Front Row?	Voting Points	Vote (Yes/No/NA)	“Yes” Points	“No” Points
3	No	2	NA	---	---
4	No	2	NA	---	---
5	No	2	Yes	2	---
6	No	2	Yes	2	---
7	No	2	No	---	2
8	No	2	NA	---	---
9	No	2	Yes	2	---
13	Yes	4	No	---	4
14	Yes	4	No	---	4
15	Yes	4	No	---	4
16	Yes	4	Yes	4	---
17	Yes	4	Yes	4	---
18	Yes	4	NA	---	---
19	Yes	4	NA	---	---
20	Yes	4	NA	---	---
21	Yes	4	NA	---	---
22	Yes	4	Yes	4	---
23	No	2	NA	---	---
24	No	2	NA	---	---
25	Yes	4	No	---	4
26	Yes	4	Yes	4	---
<b>Total</b>	<b>12</b>	<b>66</b>	<b>40/66 votes &gt; 33%</b>	<b>22</b>	<b>18</b>

NA = “Not Applicable” since no response was submitted by the benefited receptor

- Greater than 50% of voted points were in favor of the proposed noise wall – *Those benefited by the wall voted in favor of the wall.* (See Section 4.2.1.4)
- Since the noise wall being considered for CNE 2 is feasible and reasonable, this proposed noise wall is likely to be implemented as part of the project. Based on this evaluation, the likelihood statement found in Section 6.1 should be included in the technical report and NEPA document.

**Example Project #2**

Identical project to Example #1, with different project area data – Noise Analysis Required

**Receptor Selection**

See Example #1.

**Noise Level Predictions**

This example uses different traffic noise modeling data and therefore different traffic noise levels for the existing, no-build, and build scenarios were predicted as summarized in Table C-5. This results in an impact at the representative receptor R1.

**Table C-5  
Traffic Noise Prediction Results**

Receptor / CNE	Activity Category/NAC	Existing Noise Level, dB(A)	No-Build Noise Level, dB(A)	Build Noise Level, dB(A)	Increase from the Existing to Build Scenario, dB(A)	Impact Finding
R1 / CNE 1	B/67	63	64	75	12	Impact
R2 / CNE 2	B/67	65	67	70	5	Impact

**Traffic Noise Impact Identification**

- Receptor R1 is impacted, as it exceeds the FHWA NAC, and a noise abatement analysis is required.
- Receptor R2 is impacted, as it exceeds the FHWA NAC, and the noise abatement analysis for this CNE is as shown in Example #1. The noise wall for CNE 2 was found to be feasible and reasonable in Example#1.

**Abatement Analysis**

For abatement analysis purposes, the individual receptors for CNE 1 are identified, depicted in Figure C-7.

- Abatement analysis is performed for CNE 1 by considering the identified individual receptors.
- **Feasibility criterion** checked first: Wall can be built that provides at least a 5 dB(A) traffic noise reduction at an impacted receptor (5 dB(A) at R1) and possible to build – *Feasibility Criterion passed*
- **Reasonableness criterion 1** checked next: Figure C-8 shows that wall can be built for R1 that provides at least an 8 dB(A) traffic noise reduction at a benefited receptor (3 benefited receptors of 8 dB(A) or greater) – *Noise Reduction Design Goal passed*
- **Reasonableness criterion 2** checked next: The receptors identified as benefited (at least a 5 dB(A) traffic noise reduction) within the CNE must not exceed the adjusted allowable noise abatement cost.

To determine the adjusted allowable noise abatement cost, each benefited receptor, the build noise level, increase in traffic noise between the existing and build scenarios, and the dates the homes

**Figure C-7  
CNE 1 Receptors**



**Figure C-8  
Noise Reduction, dB(A)**



were built in relation to when the roadway was built must be determined for each benefited receptor. These factors are defined in Figure C-9 and Figure C-10 and summarized in Table C-6.

**Table C-6**  
**R1 Adjusted Allowable Cost per Benefited Receptor Calculations**

Benefited Receptor Number	Build Noise Level, dB(A)	Increase in Noise, Existing to Build, dB(A)	Homes Built Before Roadway, Yes/No	Traffic Noise Factor	Noise Increase Factor	Homes Built Before Roadway Factor	Total Reasonableness Factors Cost Adjustments	Total Adjusted Allowable Cost per Receptor
7	73	11	Yes	\$1,000	\$2,000	\$5,000	\$8,000	\$38,000
8	73	11	Yes	\$1,000	\$2,000	\$5,000	\$8,000	\$38,000
9	73	11	Yes	\$1,000	\$2,000	\$5,000	\$8,000	\$38,000
10	73	11	Yes	\$1,000	\$2,000	\$5,000	\$8,000	\$38,000
11	73	11	Yes	\$1,000	\$2,000	\$5,000	\$8,000	\$38,000
12	73	11	Yes	\$1,000	\$2,000	\$5,000	\$8,000	\$38,000
18	74	12	No	\$1,000	\$2,000	\$0	\$3,000	\$33,000
19	75	12	No	\$2,000	\$2,000	\$0	\$4,000	\$34,000
20	75	12	No	\$2,000	\$2,000	\$0	\$4,000	\$34,000
21	75	12	No	\$2,000	\$2,000	\$0	\$4,000	\$34,000
22	74	12	No	\$1,000	\$2,000	\$0	\$3,000	\$33,000
23	73	11	No	\$1,000	\$2,000	\$0	\$3,000	\$33,000
24	74	12	Yes	\$1,000	\$2,000	\$5,000	\$8,000	\$38,000
25	74	12	Yes	\$1,000	\$2,000	\$5,000	\$8,000	\$38,000
26	75	12	Yes	\$2,000	\$2,000	\$5,000	\$9,000	\$39,000
27	75	12	Yes	\$2,000	\$2,000	\$5,000	\$9,000	\$39,000
28	75	12	Yes	\$2,000	\$2,000	\$5,000	\$9,000	\$39,000
29	75	12	Yes	\$2,000	\$2,000	\$5,000	\$9,000	\$39,000
30	75	12	Yes	\$2,000	\$2,000	\$5,000	\$9,000	\$39,000
31	75	12	Yes	\$2,000	\$2,000	\$5,000	\$9,000	\$39,000
32	75	12	Yes	\$2,000	\$2,000	\$5,000	\$9,000	\$39,000
<b>Average</b>	---	---	---	<b>\$1,476</b>	<b>\$2,000</b>	<b>\$3,571</b>	<b>\$7,048</b>	<b>\$37,048</b>

The cost per benefited receptor for the feasible noise wall is compared to the average allowable cost per benefited receptor to determine cost effectiveness. The cost of the noise wall is calculated at \$30 per square foot, detailed in Table C-7.

**Figure C-9**  
**Build Noise in dB(A)**



**Figure C-10**  
**Increase in Noise in dB(A)**



**Table C-7**  
**R1 Traffic Noise Abatement Results**

Wall Length, feet	Wall Height, feet	Total Wall Square Footage	Total Noise Wall Cost	Total Benefited Receptors	Noise Wall Cost Per Benefited Receptor	Allowable Cost Per Benefited Receptor
1,400	19	26,600	\$798,000	21	\$38,000	\$37,048

Since the noise wall cost per benefited receptor is more than allowable cost per benefited receptor, the noise wall for CNE 1 is not reasonable to construct – Wall is not cost effective, stand-alone.

- *Cumulative Noise Wall Assessment* checked:
  - Since the noise wall meets the feasibility criteria but fails the reasonableness criteria, the noise wall can be analyzed cumulatively with the reasonable and feasible CNE 2 noise wall (detailed in Example #1) in the same project area. This cumulative analysis is detailed in Table C-8.

**Table C-8**  
**Cumulative Traffic Noise Abatement Results**

Receptor / CNE Analyzed	Wall Length, feet	Wall Height, feet	Total Wall Square Footage	Total Noise Wall Cost	Total Benefited Receptors	Noise Wall Cost Per Benefited Receptor	Allowable Cost Per Benefited Receptor	Ratio (Allowable Cost/ Actual Cost of Noise Wall)
R2 / CNE 2	1,500	12	18,000	\$540,000	21	\$25,714	\$31,142	0.83
R1 / CNE 1	1,400	19	26,600	\$798,000	21	\$38,000	\$37,048	1.03
<b>Cumulative</b>	<b>2,900</b>	<b>---</b>	<b>44,600</b>	<b>\$1,338,000</b>	<b>42</b>	<b>\$31,857</b>	<b>\$34,095</b>	<b>0.93</b>

- Since the cumulative allowable cost per benefited receptor is more than the cumulative noise wall cost per benefited receptor, both noise walls are now reasonable and are likely to be implemented, dependent on the viewpoints of the benefited receptors. *The wall is cost effective, cumulatively.*
- **Reasonableness criterion 3 checked last:** The viewpoints of benefited receptors from the two walls at CNE 1 and CNE 2 are surveyed. The survey results for CNE 2 are detailed in Example Project #1, and resulted in a noise wall that is likely to be implemented. The survey results for CNE 1 are detailed in Table C-9.

**Table C-9  
CNE 1 Benefited Receptor Survey Results**

R1/CNE 1 Benefited Receptor Number	Front-Row?	Voting Points	Vote (Yes/No/NA)	"Yes" Points	"No" Points
7	No	2	Yes	2	---
8	No	2	Yes	2	---
9	No	2	NA	---	---
10	No	2	Yes	2	---
11	No	2	Yes	2	---
12	No	2	NA	---	---
18	No	2	NA	---	---
19	Yes	4	NA	---	---
20	Yes	4	No	---	4
21	Yes	4	NA	---	---
22	No	2	NA	---	---
23	No	2	Yes	2	---
24	Yes	4	No	---	4
25	Yes	4	NA	---	---
26	Yes	4	NA	---	---
27	Yes	4	No	---	4
28	Yes	4	NA	---	---
29	Yes	4	NA	---	---
30	Yes	4	NA	---	---
31	Yes	4	NA	---	---
32	Yes	4	NA	---	---
<b>Total</b>	<b>12</b>	<b>66</b>	<b>22/66 voted &gt; 33%</b>	<b>10</b>	<b>12</b>

NA = "Not Applicable" since no response was submitted by the benefited receptor

- More than 1/3 of benefited receptors responded
- Less than 50% of voted points were in favor of the proposed wall. *Those benefited by the wall voted against the wall.*
- The proposed noise wall meets the feasibility criterion and the NRDG and cost effectiveness components of the reasonableness criterion; however, those who would be benefited by the wall were not in favor of the wall. *The proposed noise wall would likely not be implemented as part of the project.*